

THE WIRELESS WORLD

JUL 24 1917

UNIV. OF MICH,
LIBRARY

Giant Japanese
Station

JULY
1917

The Valve and
Continuous Waves

6^{D NET}

—
President Wilson's
Decree

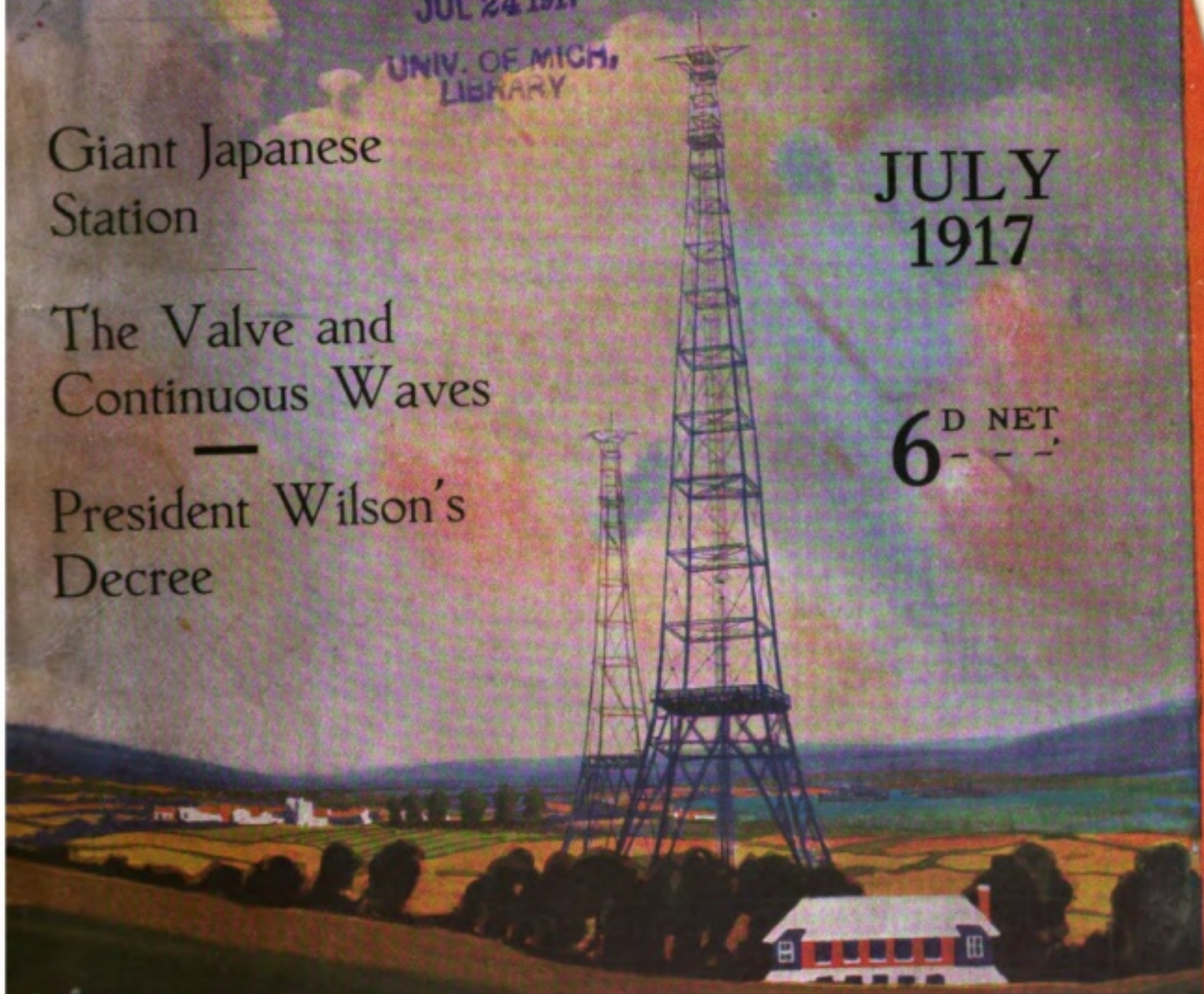

Sort
over
the
br
o
r**SULLIVAN INSTRUMENTS**

Sullivan "Universal" Galvanometers and Shunts for Land and Sea Use.

SULLIVAN TELEPHONE RECEIVERS.

Fast Speed Wheatstone Automatic Transmitters and Receivers, guaranteed at 400 words per minute, and Wheatstone Apparatus generally.

Precision and Standard Measuring Equipments for D.C. and A.C. (high frequency) determinations, Condensers of Low Power Factor, etc.

H. W. SULLIVAN WINCHESTER HOUSE, LONDON, E.C., ENGLAND.
Works: LIVERPOOL HOUSE, MIDDLESEX ST., LONDON, E.C.

Telegrams: "Deadbeat, London."

Telephone: Office: 3518 London Wall.
Works: 3518a " "Silk and Cotton Covered H.C. Copper Wire, Resistance Wires, Fuse Wire,
Binding Wires, Charcoal Iron Core Wire, Asbestos
Covered Wire.**P. ORMISTON & SONS, 79, Clerkenwell Road, London, E.C. 1.**
(P. J. ORMISTON & P. H. ORMISTON.) "Ormiston, London" Established 1793. 13259 Central.
Braided
and Twisted Wires, Bare
Copper Strand & Flexibles of any Construction, Wire
Ropes & Cords, down to the finest sizes, in Galvanized Steel, Phosphor Bronze, etc.**NORMAN, SMEE & DODWELL**MANUFACTURERS OF HIGH-CLASS VARNISHES for Coach
Builders and Decorators, Railway Carriage and Locomotive Builders, and
Ship Builders. Special Insulating Varnishes for Electrical Purposes

Offices and Factory: MILES LANE, MITCHAM, SURREY.

Prepare for the Trade Boom after the War!

There is sure to be a great demand for those who can speak, write and understand

**FRENCH, RUSSIAN,
SPANISH, OR EVEN GERMAN**

Hugo's 1917 Self-Tuition System is entirely different from anything ever attempted in Language Teaching. Hugo's 1917 Self-Tuition System enables you, even if you do not know one single word of French, to begin from the very outset to form hundreds of conversational sentences, as used by natives. This is possible only by the aid of Hugo's Practice Tables and Vocabularies. You will not only be able to write the sentences; you can pronounce them correctly by Hugo's Imitated Pronunciation.

HUGO'S 1917 Self-Tuition Course. By Post**2/6** MONTHLY FOR ONE YEAR **2/6**
or 27/- in advance

For this 30s. you receive: Fifty Self-Tuition Lesson Booklets sent post free, weekly, as well as Hugo's Unique Practice Tables and Vocabularies. These alone are worth the 30s. In addition you receive Hugo's up-to-date text books, selling price of the French, 12s. 6d. These are the best books ever written for quickly acquiring Reading, Writing, Conversation, and Commercial Correspondence. Also six Class or Private Lessons, oral or postal. For Prospectus apply to 33 Gracechurch St., E.C. Specimen Booklet sent free if "Wireless World" mentioned

HUGO'S CONVERSATIONAL CLASSES.

FRENCH, RUSSIAN, ITALIAN, or SPANISH Taught in 24 Lessons. Evening—French, 1s. per week. Day or Evening.—Special Classes, limited to 5 members, French, Spanish, or Italian, 1s. 6d. per week. Russian, 1s. 9d. per week. Private Lessons from 3s. an hour.

NATIVE TEACHERS **BOOKS INCLUDED** **FEE PAYABLE QUARTERLY****HUGO'S LANGUAGE INSTITUTE** (Established more than 40 Years)
64-66 Oxford St., W. 33 Gracechurch St., E.C. 3. 205 Earl's Court Rd., S.W. 5.

Please mention "The Wireless World" when writing to Advertisers.

The WIRELESS • WORLD •

Volume V.

No. 52.

JULY, 1917.



In the Land of Chrysanthemums

The Japanese Wireless Station at Funabashi

THE recent opening of a wireless service between Japan and the United States (reported in our February issue, page 813) has directed attention towards the new and powerful wireless installation at Funabashi, near Tokio. Erected on a site which is ideal from the standpoint of the wireless engineer and within full view of the famous extinct volcano Fujiyama, the station buildings and masts cover an area of about 110 acres. Here we find erected a group of nineteen masts, the tallest, over 650 feet in height, being situated in the centre of a ring of eighteen 260-foot masts, which support the giant umbrella aerial. These outer masts are placed equidistant from each other and some 1,300 feet from the central tower.

As will be seen from our illustrations, the masts themselves are of triangular lattice form. They rest upon ball and socket joints, and are thus not self-supporting. Each mast stands upon a concrete block from which it is insulated by means of porcelain, the steelwork being held vertically by means of three groups of guys attached to the tower at four separate points. Each guy wire is insulated from the tower and the earth, and is prevented from swinging unduly in any high wind by means of a pair of light wire guys. The amount of steel in the central tower is no less than 141 tons, and this enormous weight is borne on a concrete block containing

250 cubic feet of material. Owing to the great strain placed upon them the anchorages are of massive construction and contain each 1,000 tons of concrete. The anchorages for the accessory masts are of a similar massive construction. The illustration on page 224 shows the central mast with its surrounding towers. The enormous expanse of aerial may be judged from the fact that the diameter of the circle of masts is roughly half a mile.

The system of earth wires exhibits certain features of interest. As the station buildings are immediately beneath the aerial, and in order that the electrostatic field between the aerial wires and the earth may not be distorted, the earth wires are carried *above* the station buildings on a circle of low masts which form a ring around the station. These wires, which radiate from the centre of the station like the spokes of a wheel, are led from the ring of masts into the earth, where they are carried out to the extremes of the station site. The effect is thus as if the station buildings were buried beneath the system of earth wires, and it has been found that by adopting this plan better radiation and reception are obtained.

Regarding the arrangements within the station, we can give few particulars, as the plant is controlled by the Japanese Government, who naturally wish to keep the plans secret. It may, however, be mentioned that the prime mover is a Diesel engine of 500 horse-power driving an alternator of 500 cycles, which in turn provide energy for a bank of transformers. The transformers charge a battery of oil-filled condensers, which discharge through groups of quenched-spark gaps. Owing to the tremendous



THE FUNABASHI STATION, SHOWING THE MAIN MAST, 650 FEET HIGH.



[Photo: Underwood.]

FUJIYAMA : LOOKING DOWN INTO THE CRATER.

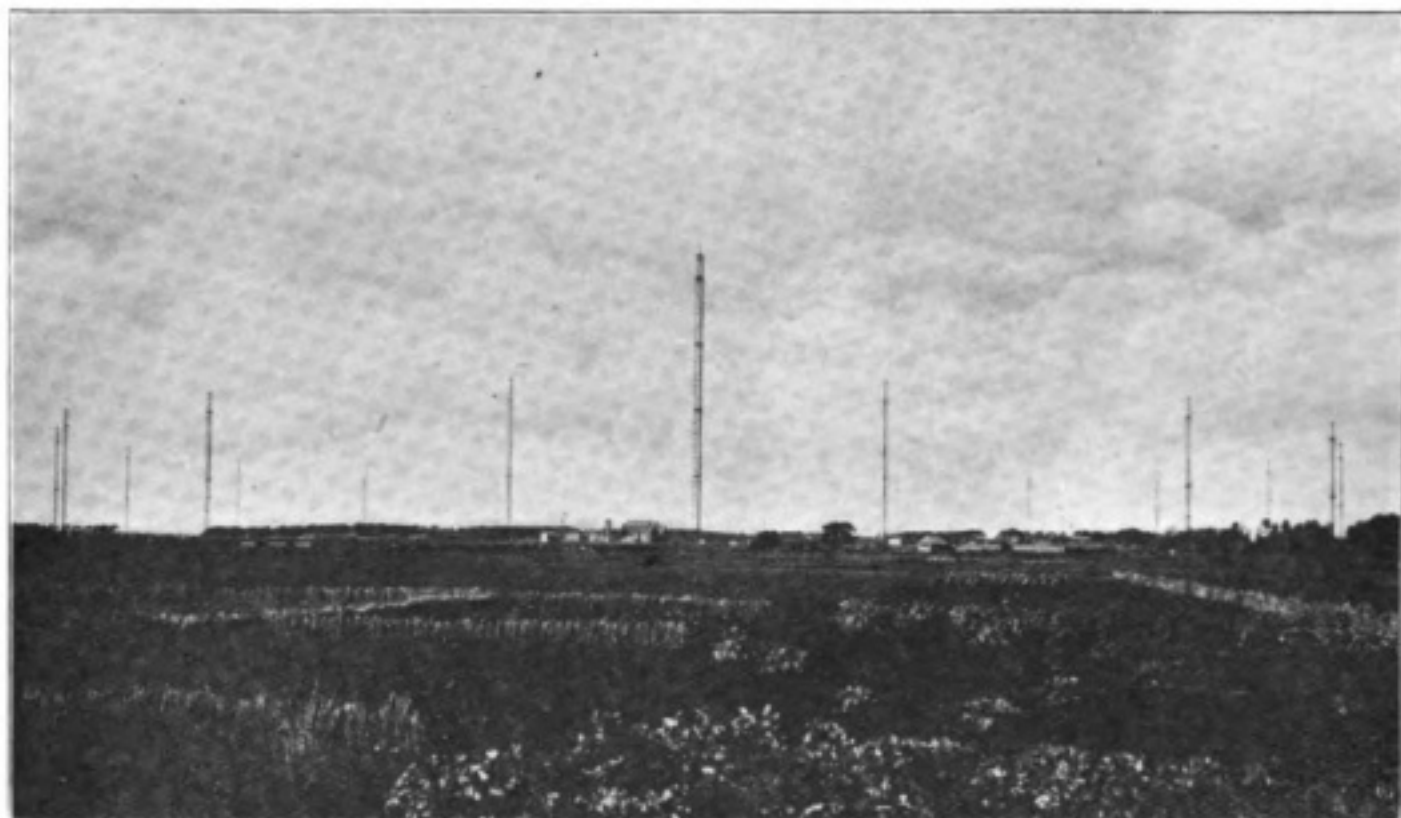

THE FUNABASHI STATION, SHOWING THE 650 FEET CENTRAL MAST AND THE EIGHTEEN SURROUNDING MASTS EACH 260 FEET HIGH.

energy which passes through these gaps they have to be cooled by continuous blasts of air from a number of blowers. The transmitter is rated at 250 kilowatts.

We believe the receiving instruments to be of the Teishinsho type, which has been developed by Japanese experts on their own lines. In this connection we would refer our readers to the excellent article by Dr. Wichi Torikata on "Radiotelegraphy and Telephony in Japan," which appeared in our April issue.

The wireless operators at Funabashi are particularly fortunate in the situation of their station, and will be envied by many of our readers who are placed in less favourable locations. Japan is, undoubtedly, one of the most beautiful countries in the world. The richness of the foliage in its plains and valleys surpasses that of any other extra-tropical region, whilst its beautiful hill slopes and forest-clad heights, its numerous alpine peaks and waterfalls, its beautifully picturesque coastline and many other features all combine to give the country an exceptional attractiveness to the European. The beautiful cone on the sacred mountain of Fujiyama—the outline of which seems to appear in every Japanese landscape—rises from the sea to a height of over 12,300 feet. The mountain is really a dormant volcano, and by reason of its height is snow-capped all the year round. On another page we give a photograph showing one of the inner walls of this crater.

A visitor walking through the streets of a Japanese town will see many vivid splashes of colour in the costumes. The town dress of a Japanese gentleman consists of a loose silk robe extending from the neck to the ankles but gathered in at the waist, round which is fastened a girdle of brocaded silk. Over this a loose, wide sleeve jacket is worn, and the attire is completed by white cotton socks and wooden pattens. Officials will be seen to be clothed in the conventional European attire, for this has been prescribed as the official dress by the Government. The women wear a loose

robe, overlapping in front and fastened with a broad girdle of silk. In winter a succession of these robes are worn one over the other. Except in the case of those

who endeavour to follow the European fashion hats are not generally worn. Another point remarked by the European traveller is the absence of jewellery, although the women powder profusely and dye their lips a deep red.

It will be interesting to watch the development of the language question in Japan due to the introduction of wireless with its increased facilities for com-



munication with the outer world. A movement, powerfully supported, has been on foot for several years to introduce the Roman alphabet, a reform which would save much tedious labour, as Japanese youths have to spend years in familiarising themselves with the difficult Chinese ideographs. At present the language, though capable of expressing almost every shade of thought required in a modern civilisation, has a



[Photos: Underwood.]

ABOVE, THE APPROACH TO A TEMPLE;
BELOW, A JAPANESE STREET SCENE.

number of drawbacks, amongst which may be mentioned the fact that the colloquial and written styles differ wholly. Moreover, there are numerous characters pronounced exactly the same. "The old order passeth giving place to new," and much that was picturesque is vanishing with the primitive and isolated condition which gave rise to it. Take, for instance, those two picturesque varieties of Palanquin, the *Kago* and the *Norimono*. In the level districts both have been superseded by the *Jinriksha*, a two-wheeled perambulator, drawn by a runner. Our picture (below) illustrates this peculiar carriage, which although generally associated with Japan as an essentially native peculiarity is of later introduction than the two first-named conveyances.

At present the Funabashi station is the only high-power station in Japan. It is giving excellent service, and, although a great deal of the traffic between this station and San Francisco is carried out through the intermediary of the Honolulu station in the Hawaiian Islands, accounts from the American station indicate that signals are frequently received direct from Japan with considerable strength. Reports from the Continent indicate that Funabashi has been heard as far west as Berlin, and we have reason to believe that excellent signals are heard in Australia. In view of this our friends the Japanese have every reason to congratulate themselves on the success they have attained, and we look forward to considerable developments in this charming country in the near future. The contrast between the ancient and modern in the "land of the chrysanthemum" is growing daily more marked, and the proximity of a giant wireless station to the picturesque scenes depicted in our illustrations is yet one more indication of the progress made by our Eastern Ally.



[Photo: Underwood.]

A MORNING RIDE IN A JINRIKSHA.

Wireless Lifesaving

In the Mediterranean Sea

FOR obvious reasons the intelligence concerning the torpedoing of transports and other Government vessels is carefully "guarded," so long as the nature thereof renders any possible information likely to be of use to the enemy. It is for this reason that many of the most interesting stories are somewhat belated in their appearance. For instance, it was only quite recently that the Press have been allowed to publish an account of the adventures of Lieutenant S. Hall, an officer of the Macclesfield Territorial Battalion of the Cheshire Regiment, wherein he describes the torpedoing of the troopship *Ivernia* in the Mediterranean Sea on New Year's day, and the way in which the rescue of those on board was effected through the means of wireless telegraphy. Lieutenant Hall draws a graphic picture of the sudden interruption of an enjoyable game of deck quoits by "a tell-tale line of bubbles and foam coming directly towards us." The gallant officer had the misfortune to form one of the party in a boat which was unsatisfactorily launched, and all of whose occupants were pitched headlong into the sea. As soon as he "came to the surface and got the water out of his eyes," he found that he was being swept rapidly past the *Ivernia*; but was ultimately pulled on to a raft, where for a few minutes he suffered from violent sickness as a result of the salt water he had swallowed. The S O S signals, which had been radiated from the transport's aerials, summoned to their assistance a number of trawlers which had passed them earlier in the morning as well as various vessels of war. Captain Turner (late of the *Lusitania*) was in command of the *Ivernia* and managed to keep his vessel afloat for over three hours after she was struck. The troops who had not been able to get away on the boats or rafts and who crowded the decks of the stricken liner owed their safety to the good seamanship displayed and the promptitude with which wireless had got into touch with the rescuers. After their more pressing needs had been served came the turn of those upon the rafts, and Lieutenant Hall describes the heartfelt relief of himself and his companions at the conclusion of their four hours of anxious vigil. He winds up his highly graphic and interesting narrative with the eloquent comment:—"No praise is too high for the splendid work done by the officers and crews of the destroyers and trawlers both in picking up survivors and attending to them afterwards."

A Mysterious "Wireless Chief"

AMONGST the recent announcements of the New York Police, with regard to enemy conspiracies which abound just now in the U.S.A., we notice a statement to the effect that they possess positive information of a visit paid by the "Chief of the German wireless system" to the United States in order to make plans regarding the fitting up of wireless and the arrangement of other details through which information was to be conveyed to Berlin. Up to the present the identity of this mysterious "Chief" has not transpired!

PERSONALITIES IN THE WIRELESS WORLD



SECOND-LIEUT. R. N. VYVYAN, R.F.C.



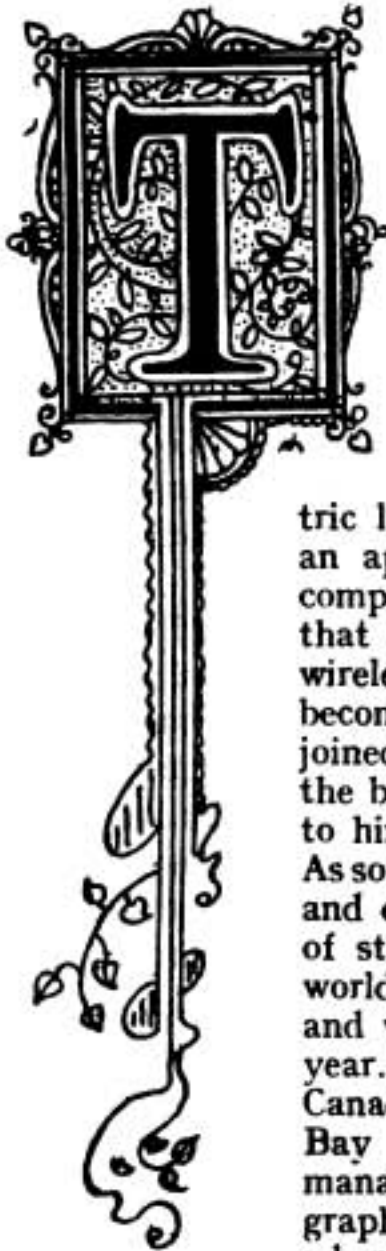

THIS month our portrait shows Second-Lieutenant R. N. Vyvyan, R.F.C. Mr. Vyvyan, who is the eldest son of the Reverend C. G. Vyvyan, was educated at Charterhouse and received an electrical and engineering training at Faraday House. On completing his training he served in the works of Messrs. Browett, Lindley & Co., S. Z. de Ferranti, Ltd., and was employed as an engineer at the Portsmouth, Whitehaven and Burton-on-Trent electric light stations. His next step was to take up an appointment as engineer to a storage battery company, and it was whilst holding this position that he first became interested in the science of wireless telegraphy. Seeking an opportunity of becoming associated with the new invention, he joined Marconi's Wireless Telegraph Company in the beginning of 1900, one of the first tasks allotted to him being the erection of the station at Poldhu. As soon as this task was completed he went to America and erected a similar station at Wellfleet, this pair of stations being at that time the largest in the world. In 1901 Mr. Vyvyan returned to England and was married in the early part of the following year. Shortly after his marriage he proceeded to Canada with Senatore Marconi to build the Glace Bay Station and following this was appointed managing engineer for the Marconi Wireless Telegraph Company of Canada at the Glace Bay Station, where he remained until 1908, in which year he

proceeded to South Africa on business connected with the proposed chain of Imperial wireless stations. After his return from Africa he went on to Spain, designing and building the chain of stations in that country and at the Canary Islands.

In the course of his activities Lieutenant Vyvyan has at various times visited Russia, France and Norway. Before the outbreak of war he held the position of superintending engineer of Marconi's Wireless Telegraph Company, and in that capacity was in charge of the designs and work in connection with the stations of the Imperial chain. The design and construction of the Carnarvon high-power station and of the Norway station, both for communication with America, were carried out under his supervision. After the war broke out he executed much important work for the Admiralty, which kept him fully occupied until the autumn of 1916, when he applied to be released in order to join the army. He is now serving in France.

The Three-Electrode Valve

Its Working and Management

(Article continued from June issue, page 164.)

THE APPLICATION OF THE THREE-ELECTRODE VALVE TO THE RECEPTION OF CONTINUOUS WAVE SIGNALS.

LAST month we described in some detail the manner in which the valve is applied to the reception of spark signals; it is also, however, peculiarly suited to continuous wave work; in fact, it is used for both the reception and transmission of continuous wave signals. A later article will be devoted to the consideration of the valve as a generator of persistent oscillations.

First of all let us consider the essential difference in the reception of damped and undamped waves. When the key of a spark transmitter is pressed a series of wave trains are sent out, one train being produced by each spark. Now each train of waves as it passes the aerial of the receiving station induces a transitory oscillating current in the receiver circuits. This alternating current is rectified by the "detector," and produces a continuous current in the telephones or in the primary winding of the telephone transformer. It should be noted that this continuous current will only be maintained as long as the oscillatory current is surging in the circuits of the receiver. Now, after the train of waves produced by a spark at the transmitter has passed the receiving aerial, the oscillatory currents in the receiver circuits die out, consequently the continuous current also ceases to flow through the telephone. Thus it is clear that each spark will produce an impulse of current in the telephone circuit, and a note will be heard corresponding in pitch with the spark frequency of the transmitter. When, however, a continuous wave signal passes the receiving aerial this note is not produced, because the continuous current impulse

will last for as long as the key at the transmitter is depressed. It is clear, therefore, that we must either (1) break up the current in the telephone circuit into a series of impulses; or (2) convert the oscillating current in the receiver circuits into a series of trains of oscillations. This latter result is obtained in effect by the "Interference" method of reception. The interference method is the one which is used almost universally at the present time, and we shall therefore confine our attention to the consideration of its application in practice.

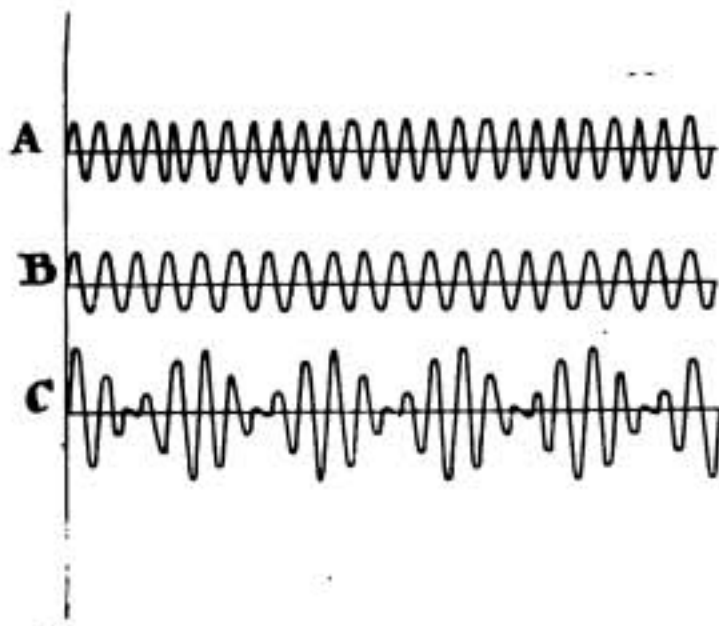

Fig. 1

The method consists in superposing upon the oscillatory current produced by the incoming signal an alternating current of slightly different frequency. The

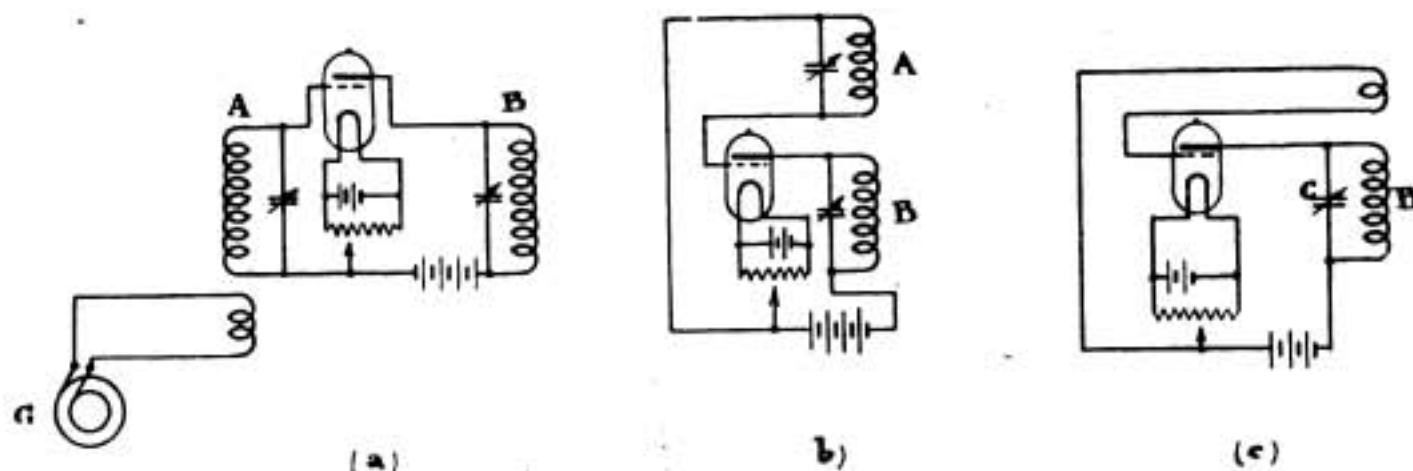

Fig. 2.

two currents are then rectified together and operate the telephone in the usual way. The signal is heard as a note whose frequency depends upon the difference of the frequencies of the incoming signal and the superimposed oscillation. The manner in which this result is produced will be clear from a study of Fig. 1. In this figure the curve *A* represents the current produced in the detector circuit of the receiver by the incoming signal. The curve is a uniform sine wave, the value of the current at any instant being plotted as ordinates, and time as abscissae. Since the amplitude of this curve is constant, the current produced in the telephone circuit after rectification will be a constant direct current of a given value. (It should be noted that although the current through the rectifier itself will be a pulsating one, each second half-wave producing a pulsation, the impedance of the telephone windings is much too high to allow the separate impulses to pass. The impulses are all smoothed out into a uniform current.) Now suppose we induce in the circuit another persistent oscillatory current of a little lower frequency, this current being represented by the curve *B*. This current again, taken by itself, would produce no sound in the telephones. If, however, the two currents are existing in the circuit *at the same time* then a different result is obtained; the effective current is then, at any instant, given by the sum or difference of the two according to whether they are flowing in the same or the opposite directions. The curve of the resultant current can thus be drawn by adding or subtracting the ordinates of the curves *A* and *B* and plotting the result. This is shown at *C*. It will be observed that the oscillations are no longer uniform, but are rising and falling in amplitude; it is clear that after rectification this varying oscillatory current will produce a note in the telephones just as the varying trains of oscillations do from a spark transmitter. It can be shown that the frequency of the note produced is equal to the difference of the frequencies of the two waves *A* and *B*. We can thus adjust the note heard to any required pitch simply by altering the frequency (or wave-length) of the local oscillations. Any receiver can be simply adapted in this way to the reception of continuous waves.

The most convenient way of generating the local wave is by the use of the

three electrode oscillation valve. Taking the first circuit described in the last article, it was explained that any oscillatory current in the tuned circuit connected between the grid and filament of the valve is magnified and reproduced in the circuit connected between the plate and filament. Fig. 2 (a) shows this circuit with the aerial and the crystal, etc., omitted, but with a high-frequency generator, *G*, inducing a persistent oscillation in the circuit *A*; the circuits *A* and *B* being tuned to the wave-length that the generator, *G*, is producing. For the purposes of explanation suppose that the current induced in the circuit, *A*, by the generator, *G*, is one milli-ampere; then, if the valve gives a magnification of, say, ten times, the current in the circuit, *B*, will be ten milliamperes. Now since the energy in *B* is so much larger than *A* there is no reason why we should not use a small part of it to maintain the oscillations in *A*—this we can do by coupling the circuits *A* and *B* loosely together as shown in Fig. 2 (b)—it is clear that we can now dispense with the generator, *G*, because *A* will have the necessary current induced in it from the circuit, *B*. A continuous high-frequency oscillation is thus maintained in *B* by the magnifying action of the valve. In practice it is found best to have *A* untuned and *B* tuned, as shown in Fig. 2 (c). The wave-length of the oscillation can then be easily and conveniently adjusted by varying the condenser, *C*.

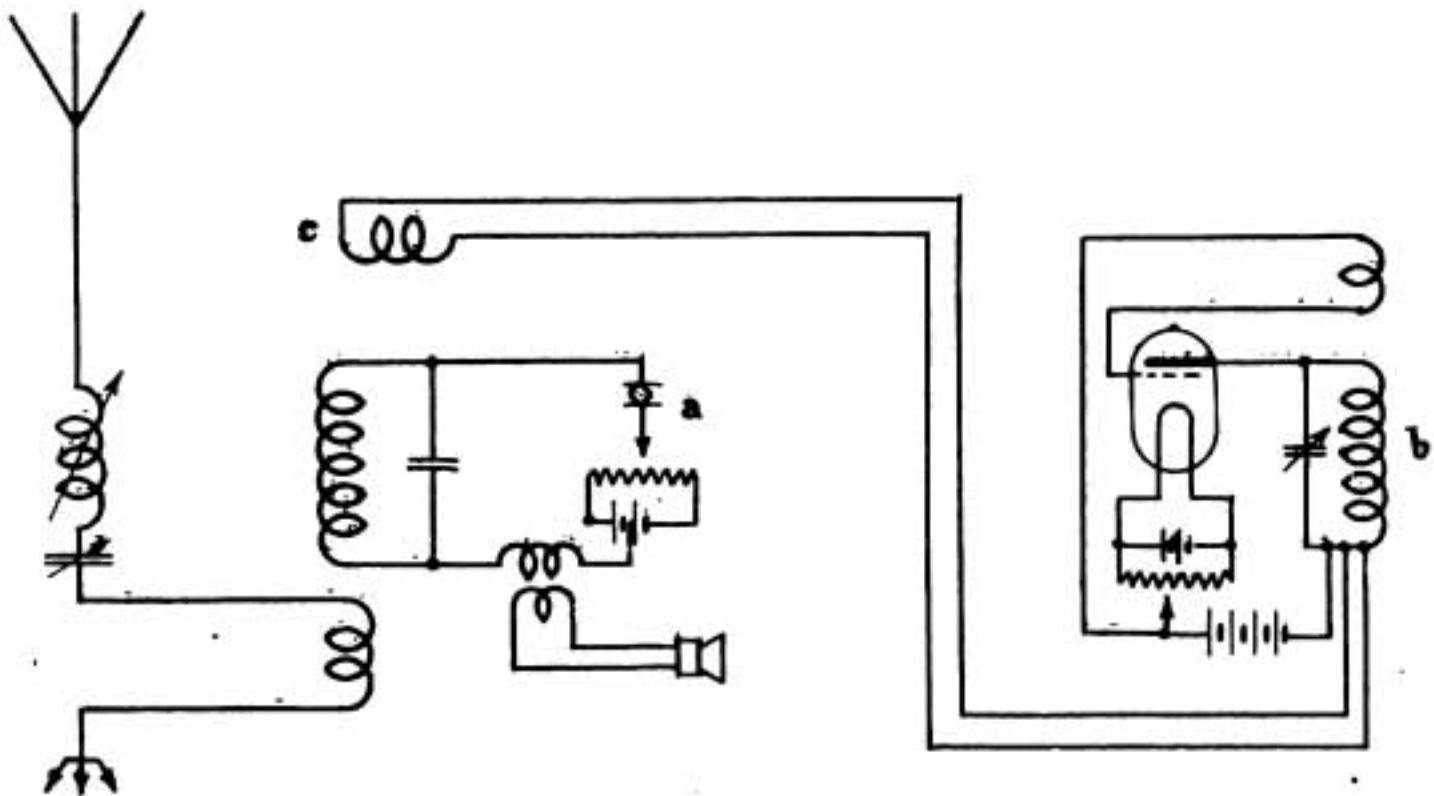

Fig 3.

Now let us see how this oscillator is applied to a receiver. Fig. 3 shows a simple crystal receiver circuit at (a) such as is ordinarily used for spark signals; coupled loosely to it by means of the coil, *C*, is the valve oscillator (b), the oscillator being tuned to a slightly different wave-length from the incoming signals. The compound wave produced, as already described, being rectified by the crystal, and heard in the telephones in the ordinary manner. We have remarked that the note produced in the telephones is of a frequency equal to the difference of the frequency

of the incoming signal and the frequency produced by the oscillator; so that if the signal has a frequency of 100,000 per second (3,000 metre wave), and we wish to have a reading note of 1,000 frequency, we must tune the oscillator to a frequency of either 99,000 per second (3,030 metre wave), or 101,000 per second (2,970 metre wave). It will thus be seen that a very small change in the wave-length of either the oscillator or the signal will result in a large change in the note heard in the telephone. This is a considerable advantage in practice, as a jamming station of nearly the same wave-length as the station being received produces a very different note in the receiver; and consequently unless very strong does not interrupt communication. In practice it is best not to have the coupling, *C*, too tight. In fact, it is often omitted altogether, the oscillator simply being placed on the table near the receiver, any chance coupling which may exist being sufficient to give the necessary interference note. If the tuning condenser of the oscillator be slowly turned a characteristic "swish" produced by interference with atmospherics will be heard as the tune passes that of the receiver. This swish is a good indication, in the absence of signals, that all is well. It is advisable to keep moving the condenser round about the point where the swish is obtained until the station required is picked up, when it can be adjusted to a point such that a good reading note is obtained. The receiver can then be finally adjusted to the exact tune of the signal. It should be noted that adjustments of the tune of the receiver only affect the strength of the signal, whereas adjustments of the tune of the oscillator alter its note without affecting its strength.

If the station cannot be picked up and no swish is heard as the oscillator tune is changed—

(1) Switch off the oscillator and make sure that the receiver is working well. This can best be done by listening to spark signals which may be coming in. In the absence of signals the tuning buzzer may be used.

(2) Adjust the coupling between the oscillator and the receiver. *This coupling should not be too tight.*

(3) Adjust the reaction coil of the oscillator, and if it is provided with a potentiometer try this in various positions.

(4) Make sure that the high-tension battery is in good condition and correctly connected up, and that the valve filament is at its proper brilliancy.

(5) Clean the safety spark-gap of the oscillator tuning condenser. A leak here, caused by allowing dust and dirt to accumulate, will prevent the production of oscillations.

Further articles on this important subject will appear in subsequent issues. These will (*inter alia*) deal with the Valve as a Generator of Continuous Oscillations.

Digest of Wireless Literature

TRAINING AVIATORS.

SOME interesting points in the training of officers in the Royal Flying Corps were dealt with by Brigadier-General Brancker in a lecture delivered before the Aeronautical Society of Great Britain. Dealing with the case of the civilian who wishes to join the Royal Flying Corps, the lecturer said that it was necessary for the man to join the Service as a cadet and go through a course in the Cadets' School, at which military subjects, pure and simple, are taught. He gets a grounding of drill and discipline, care of arms, interior economy, military law, and the use of the machine gun. This course lasts about two months. From this the cadet is sent to a Flying Corps Training School where he begins his technical training on the ground.

He goes through a course in the care of engines and rigging. He is given some idea on the theory of flight. He is taught wireless signalling and receiving. He gets instruction in the care of machine guns, in the use of the camera, in map reading, in the observation of artillery fire with models, and in his spare moments he gets a certain amount of drill. This course lasts another two months, and if he gets through this successfully he is given a commission on the General List. He then joins a preliminary training squadron as a pupil and starts his instruction usually on the Maurice Farman, his training both in military and technical subjects going on concurrently. After reaching a certain standard of efficiency and having completed a certain number of hours in the air, he is sent on to an advanced Training Squadron or Service Squadron, where he learns to fly Service types of machines for military purposes and eventually qualifies for his wings. He is then gazetted as a flying officer of the R.F.C. and posted to a Service squadron. If he shows exceptional promise as a pilot after his qualification he is sent to the C.F.S., where he is given extra higher instruction on fighting scouts. During the period of advanced training, he goes through a course of aerial gunnery away from his squadron. The total time in the air usually required to reach the qualification stage is about 30 hours solo in present circumstances, but of course the length of time that it takes to reach this standard depends entirely on the weather and the number of aeroplanes available. During the winter it works out to about four months, but in the summer it is considerably shorter.

The way in which war has forced a higher standard on us is remarkable. Only two and a half years ago, a pilot who flew across country at 3,500 feet and landed without breaking anything was considered to be quite useful. Now the expert pilot has to be prepared to fly at the greatest height his machine will reach, which is sometimes about 17,000 feet, has to dive and loop and side-slip to enable him to be

an efficient fighter, and has to have considerable experience in photography from the air, in the observation of artillery fire and the transmission of the results by wireless to the ground, and in the use of the machine gun.

* * * * *

WIRELESS AND MOVING PICTURES.

For a long time it has been the aim of inventors to produce cinematograph pictures which will speak. Many devices have already been produced, most of them combining the phonograph with the cinematograph. All previous inventions have, however, been unsatisfactory, the chief reason preventing their successful use being the difficulty of obtaining perfect synchronism between the picture and the record.

Wireless telephony is now being used in the production of talking moving pictures, and a company has recently been formed in the United States for exploiting certain inventions relating thereto. The method of working is as follows :—Each actor and actress has concealed in his or her clothing a microphone and a complete wireless telephone transmitter in miniature, the vacuum valve oscillation generator providing the necessary high frequency current. Immediately above the stage an aerial system is provided to pick up the electric waves from the actors and actresses. The radiation from these miniature transmitters is sufficiently strong to make it unnecessary to use any aerials beyond the few concealed wires in the clothing. The received oscillations are conducted to the usual type of wireless telephone receiver and here they are made to record synchronously with the film upon the band of the telegraphone—a device which records sounds upon a moving band of steel wire. When the developed picture is projected, the turn of the crank of the projecting machine also reels out the wire of the telegraphone, reproducing the voice and the picture in perfect synchronism through a number of loud-speaking telephones distributed throughout the auditorium.

* * * * *

INCREASING THE EFFICIENCY OF THE ARC GENERATOR.

An interesting note on the above subject appears in our contemporary, *Popular Science Monthly* for June. At the outset the writer reminds his readers that the arc generator of sustained waves has usually been used directly in series with the aerial in which it operates. The efficiency of this arrangement is variously stated as from 15 to 50 per cent. depending largely upon the constants of the circuits, and the details of design of the arc generator itself. The uses to which these generators have been put in the last few years has caused a great deal of study to be given to the system with a view to obtaining the highest efficiency.

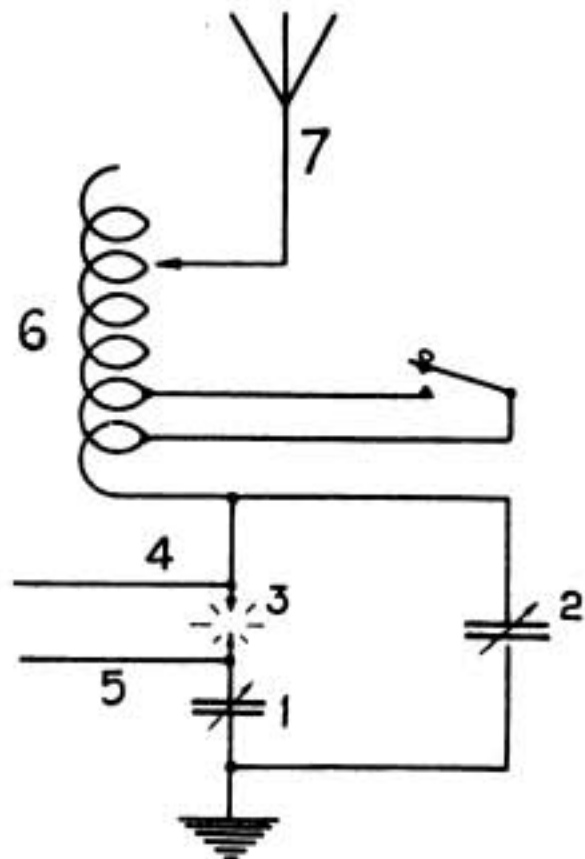

United States patent No. 1179353 of 1916 issued to L. F. Fuller shows one method of increasing the radiation or antenna current produced by an arc generator. As indicated in the accompanying figure the only material change is that of adding the two condensers 1 and 2. The first of these is placed directly in series with the one (which is supplied through leads 4 and 5 in the usual way) and the second is shunted about the arc and the first condenser. Above the arc and shunt circuit is connected the loading inductance 6, with a small portion arranged to be short-circuited by means of the signalling key; the high potential end of this coil is led directly to the aerial 7. The capacity of the two condensers is adjusted by trial and it depends upon the size of the antenna and the power of the arc. It is said that when the best values are used the antenna current is often more than doubled without using any more power than normally. The effect of the added condenser is said to reduce the effective resistance of the aerial circuit. In the old method of connection all of the aerial current passes through the arc itself, and this of course occasioned large resistance losses. In the new arrangement the larger part of the radiation current passes through the shunt condenser which has a much lower effective resistance and the wasted power is greatly reduced. By shunting the condenser 1 with a circuit containing inductance and resistance in the proper proportion, the impedance of the arc circuit is still further increased and still more of the main antenna current forced through the shunting condenser. This causes still further gains in efficiency.

With the 5 kw. arc the antenna current has been increased 100 per cent. by making the condenser 1 equal to and that of the condenser 2 twice the capacity of the antenna. Using a 50 kw. generator the current has been raised 74 per cent. by suitable adjustment of the condensers, and then additionally increased 11 per cent. by adding the shunting circuit of inductance and resistance.

* * * * *

HERTZIAN WAVES AND THE HEART.

From the *Proceedings of the Physical Society of London*, Volume 29, Part 3, we learn that at a meeting of the Society held on the 9th of March an apparatus for studying the effect of Hertzian waves on the beating of the heart was exhibited by Professor W. M. Coleman.

A simple pendulum, consisting of a cylindrical brass bob terminating in a pointed wire coaxial with the bob, hangs by a piece of string above one of the terminals of an induction coil, so that in its lowest position the point of the bob is within sparking distance of the terminal and vertically above it. The bob is connected by a piece of flexible wire to the other terminal of the coil. When the pendulum is set oscillating there is a shower of sparks every time the bob passes its lowest position. The frequency of intermittence can be varied by altering the length of the suspension. By adjusting the period of the pendulum nearly to the time of heart-beat, any possible effect on the rate of the beating may be observed. Professor Coleman stated it to be his experience that the heart-beats tend to acquire the same rate as the sparking.

The condensed discharge from two Leyden jars is employed.

* * * * *

3-ELECTRODE VALVE CIRCUITS.

The accompanying illustration is taken from an article in our interesting American contemporary *Everyday Engineering*, on 3-electrode valve circuits and

apparatus. It purports to give four of the simplest and most efficient circuits for undamped wave reception, the first being an ordinary 3-electrode valve circuit with the addition of two fixed inductances coupled inductively. A small voltmeter will serve this purpose. The coupling between the two small inductances produces a beat effect in the grid and plate circuits, making the undamped wave signals audible. The circuit is easy to adjust as there is only a voltmeter in addition to the usual apparatus. The condenser shown across the telephones and battery is not necessary and may be omitted, but usually better results are obtained with it. The second diagram shows the circuits extensively used in the United States Navy. The third circuit is perhaps the simplest of all, and here one side of the tuner is connected to the plate instead of to the filament as in the usual circuits. In the fourth diagram the aerial is joined to the plate. It is said that some operators have difficulties in making the valve oscillate with the current, but when the knack is discovered it is easy enough. The author states that with any of these circuits signals from Europe can be heard as far west as St. Louis under favourable conditions with comparatively small aerial.

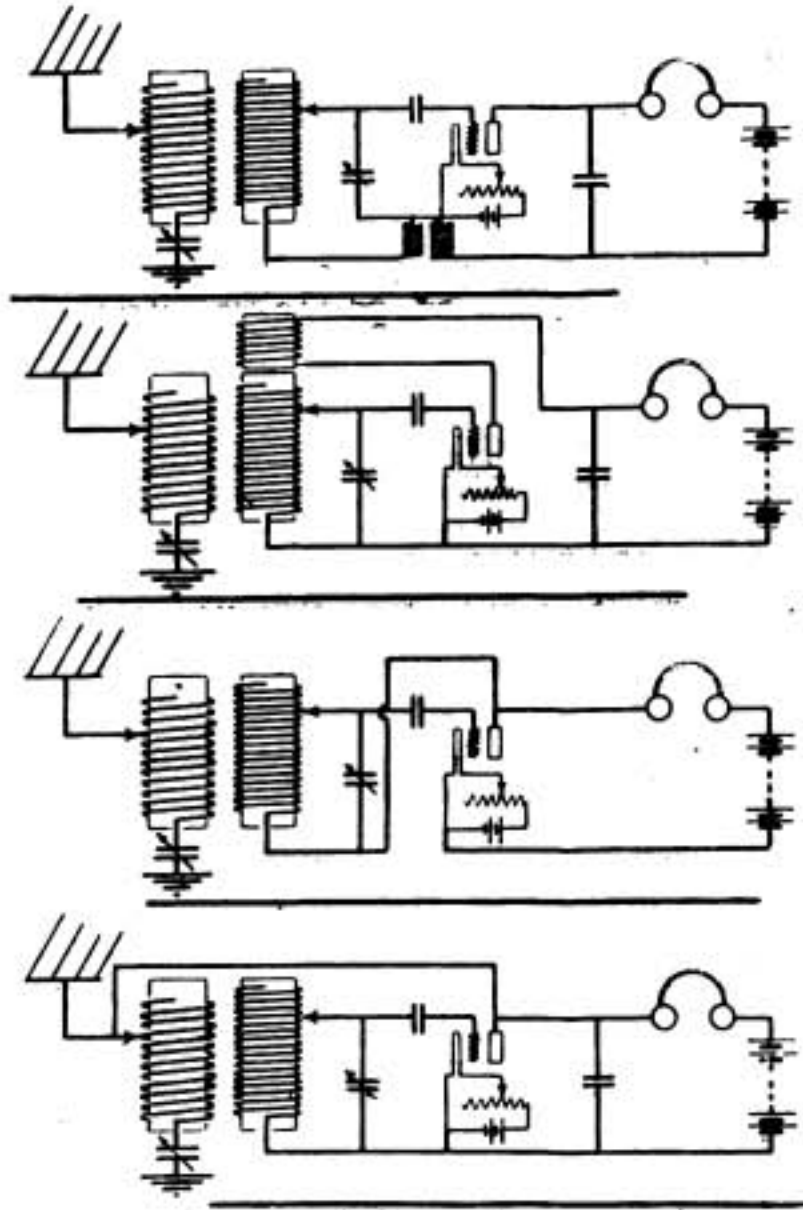

An Interesting Lecture

PROFESSOR G. W. O. Howe delivered a paper at the meeting of the Royal Society on May 10th on "High Frequency Resistance of Multiple Stranded Insulated Wire." The conductors employed in radiotelegraphy are frequently made up of a large number of fine wires separately insulated and stranded or plaited together in such a way that every wire occupies in turn the same relative position in the multiple conductor. In this way the total current is forced to distribute itself equally between all the wires even at high frequencies. Two objects are aimed at by this arrangement: (a) That of making the inductance independent of frequency, and (b) that of reducing the resistance at high frequency. Dr. Howe's paper tended to show that (b) is rarely achieved, owing to the serious loss due to the setting up of eddy currents in the wires by the magnetic influx within the conductor.

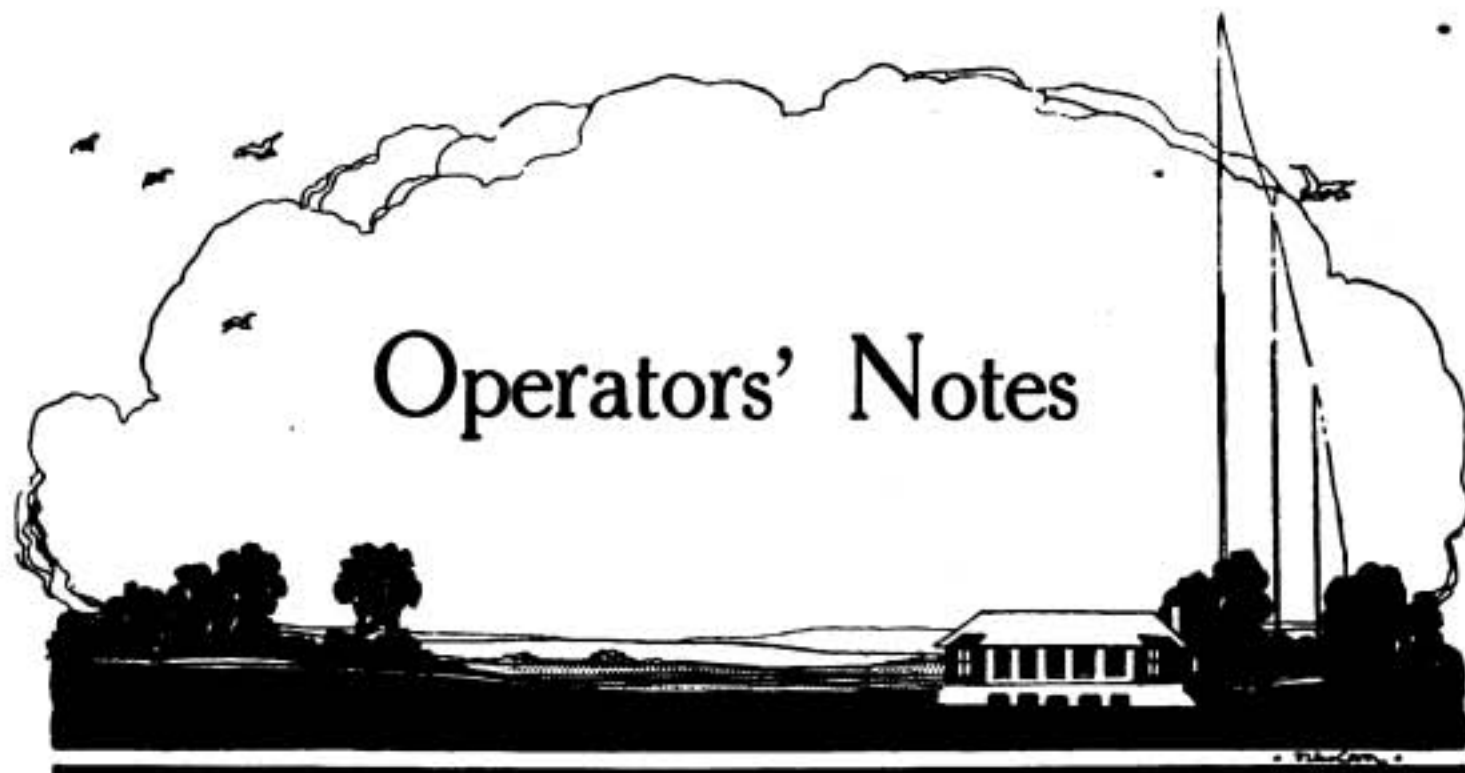

Some Hints Regarding the 1½ K.W. Converter.

THE converter must be inspected daily, and all dust and dirt removed. In no circumstances should the silence cabinet be left open when the ship is coaling, as coal-dust settling on the machine may cause a serious short-circuit. To keep the commutator clean and bright the brushes should occasionally be lifted and fine glass paper applied with a piece of wood having the same curvature and width as the commutator itself. In the event of the commutator becoming slightly grooved, polishing should be continued until all traces of it have been removed. To prevent copper and glass dust from penetrating the machine the glass paper should be smeared with vaseline and the commutator afterwards rubbed over with clean waste to remove any trace of dust and grease that may remain. Finally, the brushes should be freed from any copper or glass dust that may be adhering to them.

In certain conditions the copper will be found to wear down more rapidly than the mica, pieces of which may project, thus giving rise to considerable sparking. When the machine is at rest, and the commutator has cooled down, the metal will contract and the mica show itself, when it may be removed with glass paper. For this reason the commutator should only be polished when cold.

The slip rings should be cleaned and made smooth in the same manner as the commutator, and the same precautions taken to prevent the penetration of dust.

The tension of both D.C. and A.C. brushes should be adjusted so that they bear firmly but lightly on the copper. Too heavy pressure tends to produce grooving, unnecessary wearing of the brushes, and the formation of a carbon deposit on the commutator and slip rings. Too light pressure causes imperfect contact and chattering.

All new carbon brushes before being used should be ground so as to fit the commutator and slip rings accurately. This may be accomplished by placing a strip of fine glass paper (on which a film of vaseline has been spread) face upwards on the commutator or slip rings, putting tension on the brush and moving the armature in the direction of rotation. The rubbing should not be backwards and

forwards, as owing to the play of the brush in the holder, a slightly different curvature may be formed. On completion of grinding, the glass paper should not be pulled from underneath the brush, but released by removing the brush tension, as otherwise the curvature may be altered. Any trace of grit or vaseline must then be removed with dry waste.

With continued use the brushes wear down, making periodic readjustment of the tension spring necessary. As soon as a brush has worn down to within $\frac{1}{4}$ inch of the copper plating it should be removed and a new one substituted.

The brush holders on the D.C. side must be so adjusted on the rocker that the first and third and second and fourth are opposite one another, the first being to the left and the second to the right of the centre line of the commutator, thus allowing the whole surface to be worn evenly.

If, in spite of the precautions already mentioned, sparking at the brushes still exists, it will probably be due to displacement of the rocker, which carries the brush-holders. The four brushes which bear on the commutator are normally at neutral points, but if through loosening of the screws the rocker shifts its position, sparking will occur to a greater or lesser extent, depending on the amount of displacement.

To eliminate thin sparking the rocker must be moved to one side or the other until a point is found at which no sparking takes place. A very slight movement is usually sufficient, and the normal position will generally be found marked on the rocker and frame with corresponding file-cuts. The four screws securing the plate must be properly tightened on completion of adjustment.

Careful attention must be given to the lubrication of the machine, the grease cups for which will be found at each end of the frame. These cups must be kept filled with motor grease, which can usually be obtained from the engine room. It is not advisable to use vaseline, as this runs through the bearings too quickly when the machine becomes warm.

At intervals of a few weeks the grease should be entirely removed from the cups and paraffin run into the bearings for the purpose of removing all dirt. After this has been done, the cups must be refilled and the oil and dirt carefully wiped away from the shaft and frame.

If at any time instructions are received to remove the armature for repairs, etc., this can be done without difficulty. First, the A.C. brush rocker should be removed, then the small *inner* plate at the D.C. end, and finally the circular plate at the A.C. end. The whole armature can then be lifted bodily from the frame without disturbance to the ball bearings.

The two guard lamps must be inspected from time to time and immediately replaced if faulty, as they play an important part in safeguarding the windings from high-voltage oscillatory leaks.

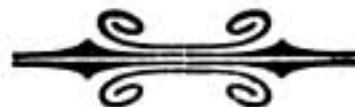

“Discovery”

or

“*The Spirit and Service of Science*”*

A Notable Contribution to the Literature of Science

Reviewed by H. J. B. WARD, B.A.

PROFESSOR GREGORY has brought together a number of examples of the methods employed by scientists, as well as of the mental attitude taken up by them towards their own discoveries, and has from these data delineated an outline-sketch of the philosophy and ethics of science in general. We turn to his preface in order to discover his own motives and the objective he set out to attain. We find that he desires to “promote a more sympathetic attitude towards those who are engaged in the pursuit of scientific truth, and to remove the widespread misconception which prevails as to the meaning and influence of science.” For my own part, I believe the eminent author to have set himself the task of flogging a phantom of what *has been* rather than of combating an actively injurious reality. Time was when popular imagination endued the man of science with the trappings of wizardry; when (for instance) the eminent Jewish physician, Michel de Notre Dame, assumed the name of Nostradamus, in order to isolate himself from the “common herd,” and veiled his real knowledge of medicine under the pretentious robes of astrology. Pictures and woodcuts of the later middle ages depict scientists as men with faces prematurely scored by furrows, living in the midst of an *olla podrida* of retorts, phials, crucibles, and other weird and necromantic apparatus. This typical mediæval seer holds one hand pressed to his brow, behind which throng all sorts of secret and awful thoughts; whilst the fingers of his other hand toy absent-mindedly with a skull, in order to indicate the scientist’s academic contempt for the ordinary frailties of mankind! These days have, however, long since passed away. The eighteenth century, when Knowledge rid herself of her last rags of mysticism and sorcery, witnessed a great upheaval in the popular conceptions of science and scientists. The confusion, caused by the dropping of old ideas and the assumption of new ones, is not ineptly voiced by Alexander Pope in his *Dunciad*:

“Physic of Metaphysic begs defence

“And Metaphysic calls for aid on Sense!”

We note in the earlier chapters some reference to the controversy between the protagonists of the so-called “rivalry” between science and “the humanities,” which survived late enough indeed to form an admirable target for the mordant goose-quill of Professor Huxley, but which has resulted in so decisive a victory for the former that we appear to be in danger of allowing the pendulum to swing too far the other way. I would respectfully suggest to Professor Gregory that nothing is

* *Discovery: or the Spirit and Service of Science.* By Prof. R. A. GREGORY. Illustrated. Cr. 8vo. Macmillan & Co. 5s. net.

more alien to the true-spirit of science than the smatterings of elementary facts which are so often advocated as good training for the rising generation. A certain school of educationists would dearly love to place their faulty schemes under the protection of science's hardly-earned prestige.

But should we, because the gifted author appears to us to have sent his book into the world with the object of attaining an end already achieved, be justified in regarding his work as supererogatory? Far from it! Let me answer the question out of the volume itself. W. H. Perkin, a lad of seventeen, during his Easter vacation in 1856 set himself the task of trying to manufacture quinine by chemical means. "In the course of his attempt Perkin attained a black mass . . . and proceeded to investigate this uninviting substance. He obtained from it, finally the violet dye known as *mauvine* or aniline purple. This schoolboy's discovery has led to the production of numerous other dye-stuffs by variations of the process invented by him, and there are now several hundreds of similar dyes on the market, all of which owe their origin to his work." This incident, quoted from Dr. Gregory's pages, would appear to illustrate his own accomplishment. He set out to dispel a *phantom* illusion and has succeeded in producing a most valuable volume which teems with delightfully written narrations of scientific achievement and with noble and stimulating thoughts. The picture of scientific ethics and methods which he has limned for us is "composed" in such a way as to make an irresistible appeal to popular imagination and to fire the enthusiasm of youth.

We notice, in Chapter X., an attempt to differentiate between *scientists* and *inventors*. The latter (according to our author) "produce something of direct service to man and from which pecuniary profit may be secured." The part assigned to the former is that of "the discovery of truth with no ulterior motives." We are familiar with this kind of classification in the field of sport. Cricketers will recall the "burning controversy" as to the difference between "Gentlemen" and "Players." Perhaps the fairest differentiation between the scientist and the inventor is that based upon the scope of their respective tasks. The former introduces to mankind the nucleus of a great body of knowledge, the latter a special application of well-known principles. But we must always remember that, under such a definition, the same man may be at one time an inventor and at another a scientist. On the borderland lines of demarcation run very faint.

The learned doctor speaks with the greatest admiration of the radio discoveries and work of Senatore Marconi, and devotes some of his most interesting pages to an account of how the great Italian scientist has laid the whole of mankind under a vast indebtedness. His pages abound with amusing instances illustrative of his various points and theories. After noting, for instance, the very human disgust with which the "open mind" even of the scientist is affected by the observation of phenomena which go to disprove a pet theory, he proceeds to illustrate his point by quoting from Sir Francis Darwin an account of his father's comment on some experiments conducted by his favourite gardener which turned out not in accordance with anticipation. After passing through the greenhouse and observing what was going on there, the great naturalist ruefully acknowledged on quitting the scene of his experiments: "The plaguy little beasts are doing just what I didn't want them to do!"

Speaking of remuneration, Dr. Gregory justly cites with approbation the action of Dr. Roux, the Director of the Pasteur Institute in Paris, who was awarded the Osiris prize of £4,000 for his discovery of the "anti-diphtheria serum," a discovery which has saved the lives of hundreds of thousands of children. Though a poor man Dr. Roux made over the whole of this amount to the Institute of which he was the head, that Institute being badly in need of funds. The millionaire founder of the prize, M. Osiris, was so struck by the Doctor's action, and the reason for it, that—at his death—it was found he had left the bulk of his own wealth, nearly one and a quarter millions sterling, to the Pasteur Institute.

We have no space to dwell upon the many delightful narratives scattered through the pages of this volume. They are told in a lively style and many of them with that "saving touch" of humour which means so much. We would refer our readers, for an example, to the story on page 57 of the great Swiss naturalist, Agassiz, who gave a fish to one of his pupils to take home and study for three days. For what happened to the fish, to the student, and to his study we will refer our readers to the book itself. There is one supreme lesson taught throughout its pages, a lesson which we venture to summarise by a slight variation upon St. Luke's words, "wisdom is justified of *all* her children."

Wireless "Recognition"

A "breaking-away" from Antiquated Tradition

MANY of our readers will be glad to hear that Captain Rupert Stanley, R.E., has recently been awarded the Decoration of the Legion of Honour for his work at the front in connection with wireless telegraphy. This gentleman occupied the post of Professor of Physics and Electrical Engineering at the Belfast Municipal Technical School in pre-war days and is the author of one of the best known text-books on wireless telegraphy, a second impression of which only appeared last year. We have here one instance out of many of the patriotic spirit with which men who had attained eminence in peaceful technical pursuits have placed their services at the disposal of their country to such a purpose that recognition of their value, from a military point of view, has come with a swiftness even more pronounced than that which attended their peace time efforts. The engineering and technical sections of all armies have been liable to find the value of their labours overlooked in favour of those of men belonging to the more showy divisions of military work. The ultra-scientific nature of modern warfare has already done a great deal to do away with these discrepancies, and we welcome the honour conferred upon Captain Stanley not merely as a personal tribute to the good work done in times of war by a man who has already won high distinction in times of peace, but also as an indication that the authorities are finding it increasingly difficult to relegate to the background the exploits and sacrifices of engineers and men employed in technical work.

Wireless Telegraphy In the War



WIRELESS ACTIVITIES, PRESENT AND PROSPECTIVE.

LAST month we called attention to the fact that wireless telegraphy "came of age" on June 2nd, the date on which, in 1896, the young Italian, Guglielmo Marconi, applied for his first British patent. One of the salient features of the current war consists of a series of striking demonstrations with regard to its progress in that short space of time. The present is the first struggle wherein wireless has played the "leading part" which is now assigned to it as a matter of course. In the Boer War, only sixteen years ago, nothing more was carried out than a few experiments whose results were all too inadequately followed up. Think for a moment what would have happened if wireless in those days had been utilised as it is to-day. After the main Boer Forces had been defeated, a guerilla warfare of a most expensive kind, both with regard to men and material, dragged its slow length over twelve weary months, simply because—in the vast expanses of South Africa—the "rounding up" forces were totally unable to maintain touch with one another. It was possible for De Wet, the most famous exponent of this species of campaigning, to appear and disappear almost at will. What a magic change has since those days "come o'er the spirit of our dream!" General Smuts in his recent East African campaign conducted operations by means of isolated columns kept in constant co-ordination through the agency of radio-telegraphy. Our able Africander fellow-citizen is well aware of his indebtedness to the science and loses no opportunity of acknowledging it. The Balkan struggles of 1912-13 witnessed some further developments with regard to this means of communication, and perhaps the most striking evidence thereof was seen in the siege of Adrianople. The beleaguered town maintained communications with headquarters in a way which no city thus invested had ever been able to effect before. It was realised, from that moment, that wireless had rendered it impossible in future to isolate any city or armed camp by means of a comparatively narrow belt of besieging troops after the fashion of warfare in the "good old days."

It has been reserved, however, for the present struggle to illustrate the full meaning of wireless in warfare. In these columns we have chronicled, month by

month, a few of the outstanding features of the wireless record. We have seen the elaborate system by which in the enemy's armies the reports of the smaller units are wirelessed, first to divisional centres, and afterwards to main headquarters, being finally despatched thence to the High Command itself. And we may fairly infer that wireless opportunities are being similarly made use of in the highly organised armies of the Allies. We have indicated the way in which co-ordination of military effort on the part of the latter is rendered possible by the utilisation of the same medium, and we have emphasised the important relations between wireless and aircraft of every description. In this present issue we include a detailed description of the method followed in "spotting" for the artillery, which re-emphasises the point that, what wireless on planes is able to do at sea for long-range weapons such as those carried on the famous *Queen Elizabeth*, it can equally effect ashore.

But, over and above the direct functions of wireless in actual military operations, we have an immense amount of indirect activities set going and maintained in motion through its agency. Right from the start, Germany has been more or less in the position of a besieged city, and has been forced to rely upon radio-telegraphy for communication to and from foreign countries outside her immediate neighbourhood. Never before has the world witnessed such a carefully organised and elaborate system of spies and propaganda, and the whole of this network is largely dependent for its efficiency upon wireless telegraphy. This is the reason why, now that America has "come in," the Germans are pressing on with the construction of their great radio station in Argentina. This in itself, apart from other causes, adds immensely to their interest in the extent to which the South American Republics will allow themselves to be swayed by the example of their Northern Sister. From the very beginning of the war, Germany has flooded neutral countries with printed matter of every description, tending to vilify their enemies, to sow dissension between the various members of the Entente, and to create false impressions with regard to what is going on, both among neutrals and her own unhappy subjects. These lucubrations she has supplemented and "fed" by floods of wireless messages, with which she keeps her home long-distance aerials busy day and night. A few selections from the multitude have been published in the newspapers of ourselves and our Allies; enough, at any rate, to give Entente newspaper readers some idea of the sort of *pabulum* which Nauener distributes with so free a hand. The absolutely mendacious nature of a great deal of it stands out so palpably to the British reading public that "German Wireless Lies" have become quite a commonplace subject of derision over here. But by no means *all* the "stuff" is of this self-convicting character; and indeed it does not at all follow that what fails to convince the British people is unproductive of effect elsewhere. So far is this from being the case that large numbers of the public in Spain, Holland, Scandinavia and even the U.S.A. for a long time were induced thereby to hold the view that—with regard to the rights of the matters at issue—it was probably a case of "six of one and half-a-dozen of the other"! Despite the natural reluctance of H.B.M. Ministers to depart from their traditional dignified attitude of reticence, they were obliged to institute some antidote to the German "Poison Gas"; and, without entering into undesirable details, we can assure readers that a good deal more has been done by the British Government

through the same medium than might be gathered from the diatribes of a certain section of the Press. *Magna est veritas et prævalebit*; our enemy's fables have been largely discredited and with vast bodies of neutrals no longer command the serious attention which they at first received. Nevertheless, Germany still finds it to her advantage to go on with the propaganda, and a curious feature in this connection consists of the fact that a whole host of these propagandist items are still radiated in English. One can only guess at the reason of this continued utilisation of a language only native to those who are in active hostility to the senders. It may be that, in view of America having merely prohibited antennæ and not all apparatus, the Germans hope that their messages may reach some "curious" souls in the New World; it may be that our enemies believe it possible to reach by this means spies or disaffected persons in Great Britain or Ireland whose receipt of wireless news might remain undetected over a considerable period, so long as they refrain from sending any in return. This must remain a mere matter of conjecture, but in any case we are confronted with the fact that Germany still considers it worth while to spend large sums of money upon the preparation and transmission of propaganda *in English*.



[Photo - Newspaper Illustrations.

A NEW U.S.A. ARMOURD OBSERVATION CAR.
THE COLLAPSIBLE TOWER IS USED EITHER
FOR OBSERVATION OR WIRELESS.

* * * * *

Such, in outline, are a few of the main features of wireless employment in times of war, and the field embraced is assuredly a wide one. But extensive as is the scope of wireless telegraphy under war conditions, the advent of peace is likely vastly to extend its boundaries. In the national interest, governments have found themselves obliged to utilise radio-telegraphy for instructing the world at large, not only with regard to their actions, but also with regard to their motives and their methods. Do they intend to "scrap" the organisations which they have set up for so doing in times of peace, and revert to their old attitude of aloofness? We suppose that there

C

are few nations more misunderstood abroad than the British. The present writer has vivid recollections of his experience with fellow-journalists in Spain during the pre-war days, which go to exemplify the extent of such misconceptions and the evils which arise from them. The path of judicious action in this regard bristles with difficulties; but, after all, the more manly way is to overcome them, and not to turn passively away. Assuredly Great Britain ought from her present troubles to have laid to heart the lesson of the dangers attending a policy of *laissez-faire*.

* * * * *

AIR, FIRE, AND ÆTHER.

The present war has been criticised as "a war of the young." Like all generalisations, the dictum requires some modification, but it is perfectly true that in no previous war has youth been so largely at a premium. Many circumstances have conduced to this end, and none more so than the fact that the strain of modern life acts more quickly upon men's nervous systems than was the case in days gone by. The result is that only fresh unracked subjects possess the necessary nervous stamina for much of the work, especially in the case of novel pursuits like those of flying and its cognate profession of wireless. A further consequence of this state of affairs is that our schoolboys are taking an unprecedentedly eager interest in all that appertains to the great struggle, a fact which is reflected in the magazines which specially cater

for them. The June issue of that good old British institution, *The Boy's Own Paper*, prints under the title of "An Aeroplane "Shoot" the experience of the Rev. A. A. Brockington (a *padre* on the Western Front), part of which we venture to quote here as an interesting account, from an eyewitness, of the details attending the process known as "spotting for the artillery by aeroplane," and which illustrates the important rôle played therein by wireless telegraphy. Mr. Brockington was asked by an old pupil, Captain C., if he would "like to see an aeroplane shoot." On



(Photo - Giles.)

RUSSIAN FLYING MEN, WHOSE QUALIFICATIONS INCLUDE A KNOWLEDGE OF WIRELESS.

receiving an answer in the affirmative the reverend gentleman and his cicerone wended their way to the "gun position."

"C., after running about from a telephone hut to a dug-out and giving various orders, sat down on a chain with a diagram and a dial in front of him. There was a sergeant-major between C. and the howitzers. The sergeant-major held an improvised megaphone. I sat down by C.'s side and was surprised to hear a voice come out of the bank close by: 'He wants to know whether you are ready, sir.' The voice belonged to a wireless operator with ears clamped fast occupying a hole in the earth. This was the observer of an aeroplane, and I was presently able to detect the flyer, poised at a considerable height apparently over the enemy's lines. C. said he was ready. Then the 'Wireless' called out combinations of letters and degrees. C. did something with a pencil on the dial or diagram and said something to the sergeant-major, who repeated the order through the megaphone. Thereupon the gunners got busy. From behind one could see the shell leave the muzzle of the howitzer. You must not believe the picturesque war correspondent who says that howitzers 'bark'—the sound of the firing is rather flat than sharp. . . . This process went on for half an hour or more. 'Wireless' transmitted the messages from the airman to C.; C. jotted down things on his paper and gave directions to the sergeant-major. The sergeant-major ordered No. 1 or 2 to make certain alterations in direction and sighting; the men shovelled in a shell and then stood away. The sergeant-major bawled 'Fire!' There was a boom, the projectile rose and soared through the air, whilst the great piece recoiled. . . . An aeroplane shoot is anti-battery work. . . . At the end of the time 'Wireless' called out: 'He says "Thank you very much, sir; the results are quite satisfactory."' C. said to me, 'The worst of it is that *he* can always talk to you and *you* can never talk to him.' C. said this with an unexpected trace of bitterness. I wonder what it was he wanted to say to the airman?"

* * * * *

PLOTS "AS USUAL."

The utter hopelessness of the wireless situation for Germany created by the entry of the U.S.A. into the present war is demonstrated by the feverish anxiety of our enemies to counter the blow. The long-distance wireless station projected in the Argentine Republic has had its "power" plans readjusted, and is to be pushed forward with all possible speed. Whether the Argentine Government will allow it to be worked, if it be ready before the struggle ends, is a matter upon which at present no forecast can be made. But, over and above this River Plate project, the disturbed state of Mexico offers an opportunity for "fishing in troubled waters" of a type which is peculiarly congenial to the German temperament. Persistent reports of the transmission of messages through Mexican long-distance wireless stations continue to reach us from the U.S.A., and we understand that the various parts of a complete wireless outfit were assembled in New York, whence they were sent on to Mexico, for erection. Indeed, the Yankee Secret Service men are being kept very busy just now unearthing plots of every description, including the use of the letter mails by ostensibly "private" individuals, and overtures to Venezuela with regard to the control of Margarita, the pearl-fishing island lying between the seaboard of that country and the British West Indies.

Wireless with the Eskimos

Diary of a Voyage to Baffin's Land and Hudson's Bay

By DOUGLAS R. P. COATS

[*Editorial Note.—The first part of this interesting Diary appeared in our April and May issues*]

Sept. 10th.—The gale continued throughout the day, causing the *Fort York* to drag her anchor and drift out of sight.

Sept. 11th.—It continued blowing hard from the south-east all day, and there was no sign of the *Fort York*. We imagined her to be blowing out into the bay and having an exceedingly bad time.

Sept. 12th.—The gale blew itself out in the night and left us with fine weather. We expected to see the schooner returning to us, but she did not appear. Our fears for her safety were growing hourly, and I wirelessly to Nelson to know if she was visible from there. Scarcely had I done so, when she came in sight. We learned later that she had drifted for a while, and then been successful in reaching York Factory.

Sept. 13th.—Capt. Mack and others went ashore in the *Fort York*, I remaining on board expecting a message from Port Nelson.

Sept. 15th.—I heard through Nelson of some recent Zeppelin raids on the east coast of England.

Sept. 17th.—I received more news from Port Nelson. Captain Mack and our passengers returned in the schooner, bringing me a huge piece of wedding cake from the brides.

Sept. 18th.—The schooner took nearly all the cargo remaining for York Factory and returned to shore.

Sept. 19th.—The *Fort York* took the rest of our York cargo and we sailed at four o'clock in the afternoon.

Sept. 20th.—I heard Port Nelson working at eleven o'clock a.m., but could not reach him myself. The sea was smooth until the evening, when the wind began to breeze up.

Sept. 21st.—A strong northerly wind blew all day, making a choppy sea. We steamed slowly into the wind so as to avoid danger from the numerous shoals which abound in James Bay, and which are very poorly charted.

Sept. 22nd.—The weather improved in the afternoon, and we were able to proceed once more on our course. The sailors were busy with the lead after dark, and at half-past ten at night a sudden sounding of five fathoms where, according to the chart, there should have been about thirty, made us drop anchor for the night.

Sept. 23rd.—Getting under way again in the morning, and proceeded slowly towards Charlton Island, sounding frequently all the time. We passed Lisbon Rock on our port side at half-past five p.m., and soon saw the "beacon" which guides the H.B.C. ships to Charlton. We anchored an hour later, and had no sooner done so than a dense black cloud darkened the sky, heavy and ominous-

looking, with lurid yellow background, which portends dirty weather. Rain commenced to fall in large drops and the wind to make a tune in the rigging, while the sea became choppy in a very short time.

Sept. 24th.—We weighed anchor at about half-past nine in morning, and went slowly ahead towards Charlton. Early in the afternoon we sighted the H.B.C. warehouse and the wreck of a barque on the shore. We anchored and waited for a pilot, but none came to us. The land appeared much more hospitable-looking than any we had yet seen, being thickly wooded.

Sept. 25th.—A small schooner put out from the shore in the morning and made very slow progress in our direction until the *Prickly Heat* went to her aid. She reached us at about eleven o'clock, bringing the mail with her. I went ashore in the afternoon and discussed the latest war news with the H.B.C. fellows, while the *Nascope* came alongside the diminutive structure which is used as a wharf.

Sept. 26th.—It was blowing hard when I awoke in the morning, and the mates were putting out additional mooring lines to the shore. I paid a visit to a stranded barque with our second mate, and found everything in a very bad state on her, anything of any value having long since been removed. Miss N—— left us here, being met by her mother, who was accompanying her to Rupert's House on the *Inencow*, a little steamer moored beside us and absolutely devoid of beauty.

We attended divine service at noon, Mr. F—— conducting it in a room near the H.B.C. office. The second mate (Mr. Arnold) and I wandered into the woods after lunch, gathering blueberries, red currants and wild gooseberries, which we found in plenty.

Sept. 27th.—Our cargo was being discharged all day into light trucks which ran on tracks along the rickety wooden pier. The reason for the "wobbliness" of this pier became quite clear to me when I heard that ice conditions made it com-



THE "NASCOPE" IN THE ICE.



AN ESKIMO ENCAMPMENT.

pulsory for the H.B.C. men to pull down the structure each fall and re-build it as soon as the summer weather sets in and the ice leaves the harbour. This must be a work of no mean magnitude for the small number of men available.

Sept. 28th.—A party of explorers joined us, returning to St. John's with us, *en route* to Toronto. The party consisting of Mr. Flaherty, Senr., Mrs. Flaherty, Junr., her brother-in-law, Mr. Flaherty, and Miss Thurston, had travelled by canoe from Cochrane to Moose, and had then taken a small schooner with the intention of going to the Belcher Islands on a prospecting expedition, but were wrecked and obliged to give up the trip as the delay had made it too late in the season.

Sept. 29th.—I went into the woods in the morning, armed with my revolver—the only weapon which I brought away with me. I saw one squirrel and a number of slate-coloured birds with white cheeks and in size about as big as a cuckoo. I made a smoky fire with moss and ate my lunch in the lee of it, so as to escape the attentions of the mosquitoes. Returning to the ship at three o'clock p.m., I was just in time to witness an exciting scene caused by six pigs who objected strongly to being taken ashore.

Sept. 30th.—The last of our cargo for this place being discharged, we took on a quantity of furs and left at half-past eleven a.m. The wind shifted from S.W. to N., and we soon ran into dense fog and anchored for the night. Capt. Redfearn, of the s.s. *Inenew*, was on board, going home to be operated upon for appendicitis.

Oct. 4th.—We arrived at Cape Wolstenholme and took away the mail after some little delay. The bold and rocky hills were more heavily flecked with snow than when we were here before, and the biting air announced emphatically the approach of winter.

Oct. 6th.—I turned out at 4.30 a.m., there being a ship in sight on our starboard side. She proved to be the *Bellaventure*, bound to Port Nelson. While talking to

her I was called by the *Sheba*, bound for the same place. Both steamers were carrying Government stores for the men at work on dredging and building up the harbour, which is to become a summer port of call for transatlantic grain carriers. At eleven o'clock this morning we reached Lake Harbour.

Oct. 7th.—The motor launch *Daryl* brought our several cargoes of furs to us, and also some barrels of fresh water. Light snow had fallen during the night, imparting a beautiful appearance to the fjord-like harbour with its narrow entrance and lofty hills. This must be the "pretty" season up here—the best substitute they have for our "fall," with its lights and shades and ever-deepening colours. It is true that their short "autumn"—the word sounds incongruous in Baffin's Land—is marked by no gold and brown, no intermediate shades and leafy colour-blends. Dame Nature's sole materials are the drab hills and the white snow, but with them



A GROUP OF ESKIMO VISITORS.

she manages to produce quite an arresting picture—a sort of crayon drawing in black and white. At two o'clock in the afternoon we left.

Oct. 8th.—Anchoring at dusk off the mouth of the Koaksook River, we endeavoured to attract the attention of the people on shore by means of our searchlight and a few rockets. No pilot came out to us, however, so we remained where we were for the night, not daring to approach closer after dark.

Oct. 9th.—At daybreak we got under way and ran towards the river mouth, picking up an Eskimo pilot at half-past nine. He refused to take us over the bar, the tide being too low, so we anchored again.

Oct. 10th.—Soon after breakfast we went up the river to Chime. The French Company has a place here also, so combined with the numerous buildings of the H.B.C. post, it forms quite a little town. A fleet of sail-boats was anchored in the stream, besides which there was a great number of smaller craft drawn up

on the shore. Two buoys marked the height of safe navigation, and here we dropped anchor.

Oct. 11th.—Going ashore in the *Prickly Heat* this morning, and strolling over the rocks and through occasional patches of boggy grass, I came upon a native



TYPES OF ESKIMO WOMEN WHO POSED FOR MR. COATS

burial place. There were graves covered with heaps of stones, and graves with little wooden crosses at their heads; but more interesting to me were the rough-hewn boxes perched upon the crags and only half-covered with stones.

The boxes had fallen apart in some cases, distributing their ghastly contents on the ground. Human skulls and ribs were to be seen everywhere, and gruesome evidences of the work of "husky" days could be traced occasionally.

I found another collection of boxes in the afternoon, and made a rough sketch to remind me of it, my films having given out.

Our farewell to Chime, and to Mr. and Mrs. Watt, our two genial passengers, the last look at the *Prickly Heat* and the sound of her engine—miss-firing as usual—as they left us, completed the trip, so far as interest goes. After a rough journey, we reached St. John's, N.F., at 8 o'clock a.m. on October 18th.

Correspondence

HIGH *versus* LOW ANTENNÆ

DEAR SIR,—In your March issue appears a digest of a paper entitled "High *versus* Low Antennæ in Radio Telegraphy," by Edward Bennett, University of Wisconsin, U.S.A.

Your digest gives the impression with, however, full authority from the original paper, that it is conclusively proved in theory that in a radiotelegraph station in transmission and in reception a low antenna is equally effective as a high antenna. The dimensions of the two antennæ other than the heights being the same in each case, the wave-length being the same and the maximum potentials to which the antennæ are charged also being the same.

This contention is so entirely opposed to present-day ideas on the subject that I undertook an examination of the paper to ascertain on what foundation the author's statements were based. I find that the whole argument of the paper is based on assumptions that are not correct in practice, and if you care to make public my criticism in your columns I shall be glad to have you do so.

The design of antennæ for wireless telegraph stations has from the outset been based on the law originally evolved by Mr. Marconi that "The distance at which signals can be received varies as the square of the height of the antenna," that is, of course, when antennæ of equal height are used for sending and receiving.*

This law has been elaborated upon in various empirical formulæ due to Austin Fuller, and others, such as :

$$I_2 = 4.25 \frac{I_1 h_1 h_2}{\lambda x} \exp. \left(-0.0015 \frac{x}{\sqrt{\lambda}} \right). \text{—Austin;}$$

$$I = 4.25 \frac{I_1 h_1 h_2}{\lambda x} \exp. \left(-Bx/\frac{3}{\lambda^2} \right). \text{—Fuller;}$$

etc., and the formula for the radiation resistance of an antenna :

$$R = 1580 \frac{h^2}{\lambda^2}$$

In the section of Professor Bennett's paper dealing with the energy received at a distant point due to an oscillatory current in a Marconi antenna, close identity with the above-mentioned formulæ can be readily established.

The first new conclusion in the paper is that any antenna has a "radiation figure of merit" represented by Ch , the product of the capacity of an antenna with the height of the capacity; and that, as in antennæ which are of large area as compared with height, as the capacity, C , varies inversely as the height, h , the radiation "figure of merit" is independent of the height, and depends only on the size or area of the antenna.

* NOTE.—A misleading feature in the comparison appears here in that no mention is made of the fact that to charge both antennæ to the same voltage would require ten times as much power in the case of the low aerial as in the case of the high aerial, due to the greater capacity of the former.

From this it is concluded that, providing the maximum potential to which the antenna is charged is the same in each case and other dimensions of the antenna are maintained the same, the effect at a distant point will be the same whether the antenna is 10 metres high or 100 metres high.

It is suggested that the large capacity of an antenna 10 metres high would permit of the use of the plain aerial system with low damping and high efficiency and the main characteristics of such an antenna and transmitter are given as follows :

Radius of capacity area	165 metres
Height of capacity area	10 metres
Capacity of area to earth	'075 M.F.
Assumed voltage at moment of discharge				100 peak kv.
Assumed frequency of oscillation			...	80,000 cy. per sec.
Energy stored per spark	375 Joules
Input at 1,000 sparks per sec.	375 kw.
Radiation resistance	'011 ohms
Logarithmic decrement per cycle due to radiation of energy	'0013

It is further stated that allowing for the I_2R losses in the conductors, ionisation losses, and the losses in the resistance of the spark which is estimated at .1 ohm, the total resistance of the antenna tending to cause damping can be kept as low as '12 ohm.

Assuming for the moment that this is possible then as the efficiency of an antenna as a radiator is determined by the ratio of its "true radiation" resistance to its total resistance, the efficiency in this case is $\frac{.011}{.12}$ or 9.1 per cent. That is to say out of the total of 375 kw. applied to the antenna some 33 kw. is usefully employed in the radiation of energy to distant points.

But it is well known that the wasteful resistance of an antenna having a natural wave-length of the order of 4,000 metres cannot be reduced to less than 1 to 1.5 ohms even with the most careful design and construction ; resistance being introduced in the surrounding ground, in the structures supporting the antenna, buildings, etc., which it is exceedingly difficult to eliminate in practice.

If, then, we consider this system as having a total resistance of the order of 1 ohm we find matters much worse, an efficiency of about 1 per cent. and about 4.0 kw. usefully employed out of the 375 kw. applied.

In the case of the receiving antenna it has again been assumed that the wasteful resistance of the antenna is a practically negligible quantity.

The repudiation of current notions on the desirability of high antennæ for radio stations is due to an incorrect conception of the conditions actually met with in practice, and the contemplated revolution in current practice must await the time when an antenna can be constructed with zero wasteful resistance.

Yours faithfully,

ALEX. E. REOCH.

GRAPHICAL SYMBOLS FOR WIRELESS TELEGRAPHY

The Editor, THE WIRELESS WORLD.

SIR,—I have read with interest the article on Wireless Symbols, in the April number of THE WIRELESS WORLD, and should like to make the following suggestions :—

It is evident that the proposed symbols do not entirely fulfil their purpose.

For instance, taking the symbols Nos. 193 and 194, transformers, and comparing them with Symbols Nos. 202 and 203, couplings, it is obvious that the symbols used are identical and therefore do not fulfil their object, as they do not specify one article only.

To make this clear I show below the symbols and the articles they are intended to represent, side by side, and underneath show alternative symbols for transformers with and without variable leakage. These symbols are distinctive from those used to illustrate couplings.

SYMBOLS AS SHOWN

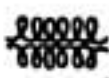
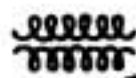
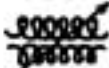
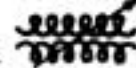
193 TRANSFORMER		202 COUPLING, INDUCTIVE	
194 TRANSFORMER, VARIABLE LEAKAGE		203 COUPLING, VARIABLE INDUCTIVE	

SYMBOLS SUGGESTED

193 TRANSFORMER		202 COUPLING, INDUCTIVE	
194 TRANSFORMER, VARIABLE LEAKAGE		203 COUPLING, VARIABLE INDUCTIVE	

With regard to the matter of variability, the generally accepted symbol for this is an arrow drawn in an angle through the symbol of the article which it is desirable to indicate as being of a variable nature. In practice, however, the arrow has proved insufficient, as it is often necessary to indicate the nature of the variability, whether continuously or in steps.

For example, take the case of an inductance or a condenser: both of these articles are frequently made so that a rough adjustment can be made in steps, and a fine adjustment by means of some continuously variable device.

For instance, in the same diagram one condenser would be adjustable by steps, and the other continuously variable; thus it is necessary to provide means whereby the two types of condenser could be identified.

As an illustration I have taken the case of the transmitting circuit as shown in the April issue (*a*), and placed alongside the same circuit re-drawn (*b*), but making use of the symbols as they are shown on page 42, and applying them in the sense in which they were intended to be used.

The inductances in the aerial and the primary circuits are shown as consisting of two variable inductances, and are placed so as to be magnetically coupled together. This necessitates the use of an arrow through each inductance to show that it is variable, and an arrow through the two inductances together to show that the coupling between the inductances is also variable.

The convenience afforded by the provision of two symbols to indicate the nature of variability is shown in the third diagram (c).

TRANSMITTER CIRCUIT
AS SHOWN

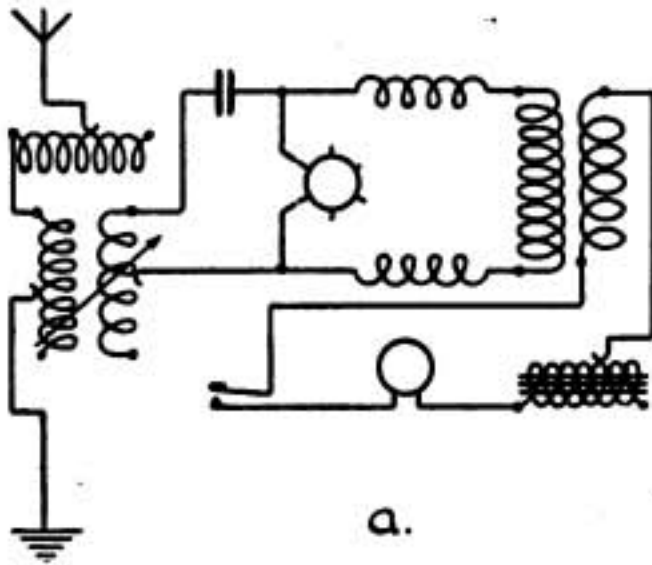

SAME CIRCUIT USING
SYMBOLS CONSISTENTLY

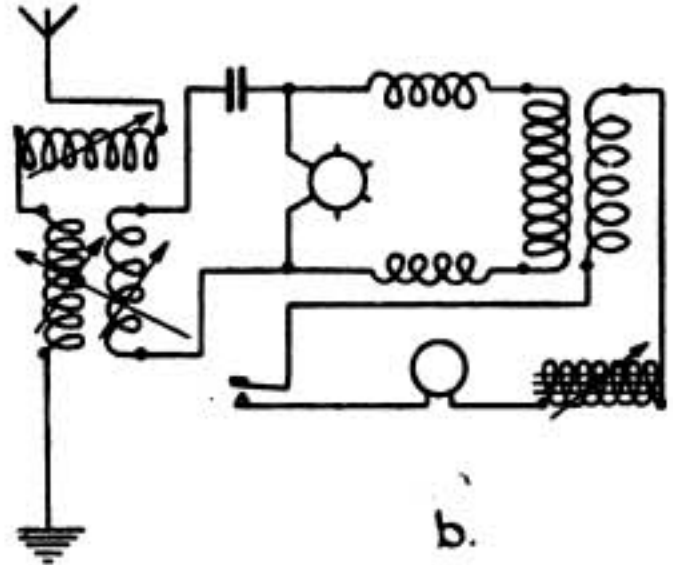

SAME CIRCUIT USING
SYMBOLS AS SUGGESTED

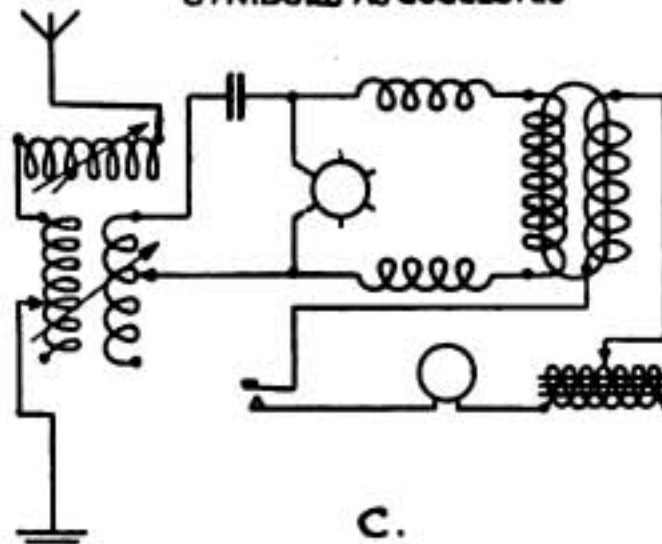

Symbol No. 180 has "Inductive Coil"; would be a better
Symbol No. 187—*rator*.—The symbol with the letters "M.G." signifies a motor generator. To see how this symbol to form part of a dia- tions in which it was show the motor and circuits.

Symbol No. 197—symbol suggested by Institute of Radio Engineers has the merit of being self-explanatory, and is therefore the better of the two.

Condensers.—A distinction has been made between one condenser and another on a frequency basis. This is a mistake in principle, and there are bound to be occasions when a single condenser could be both an audio and a radio frequency condenser; and, again, it is difficult to fix a numerical limit as to what is to distinguish an audio from a radio condenser.

Considering the wide field which has to be covered, the number of symbols provided seem inadequate, and I would suggest that the readers of THE WIRELESS WORLD be asked to give this matter their consideration, and put forward such suggestions as they may have to offer.

London :

May 25th, 1917.

been termed an "Inductance" definition. *Motor Gene-* shown—a circle written in—*erator*, but I fail could be made gram of connec- necessary to the generating

Buzzer. — The the American

197



RADIO
SYMBOL

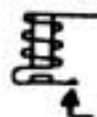

Maritime Wireless Telegraphy



U BOATS AND WIRELESS.

WE have on several occasions been able to publish illustrations depicting the arrangement of wireless aerials fitted to German submarines. It was only in last month's issue (page 180) that our most up-to-date view appeared. The radio equipment carried by the later type of U boats has shown a remarkable development on those of the earlier craft and, in combination with other improvements, is, we are afraid, responsible for a great deal of their powers of mischief. A short while ago the Dutch newspaper *Telegraaf* printed an interview with a member of the crew of the German submarine which torpedoed seven Dutch vessels on February 22nd. Incidentally we may remark that there would appear to be a peculiarly piquant flavour in this quiet record in the pages of a journal published in a "neutral" country whose neutrality does not save *them* from the depredations of war, but does give *their depredators* complete immunity from suffering any penalty at the hands of the injured party! It is as though a man whose house had been burgled were to publish an interview with the burglar wherein he recorded the criminal's account of how the robbery was committed and his own inability to hand the thief over to the police. A somewhat humiliating position for a "free and independent Sovereign State," is it not? and a curious commentary on Germany's simulated passion for "the Liberty of the Seas."

The interview tells us that the submarine was the U58, commanded by Count von Pluetau, a young man of 23, whose vessel after leaving Emden on February 19th was, on the 22nd of the same month, cruising in the neighbourhood of Falmouth. The German sailor confessed the perfect acquaintance of himself and his companions with the identity of the vessels which they were torpedoing and described how his vessel manœuvred in a zigzag line amongst its helpless victims, raining shells and bombs right and left without the slightest compunction.

Perhaps the most interesting item consists of the *Submariner's* description of the way in which he and his brother-pirates rendezvoused regularly at a fixed base, in order to receive instructions, probably from Heligoland, by wireless telegraphy.

A NOTABLE FEAT.

On April 21st last the s.s. *Benin*, a transatlantic steamer belonging to the Elder Dempster line, left Louisburg (Nova Scotia) *en route* to Cape Ray, the southwestern extremity of Newfoundland, and during the hours of daylight saw no ice. After altering her course for the island of Anticosti, at the entrance to the estuary of the St. Lawrence, she ran into a large area of "field" ice in the fog and darkness, and navigation proved extremely difficult in view of the fact that in many cases the "growlers" were many of them as high as 25 ft. above the water. Ere long the carpenter reported a leakage through ice damage in the fore peak, and Captain Jones instructed the chief engineer to start the engines gently to see if it were not possible to work the vessel out of the danger zone. The propeller snapped immediately, and the *Benin* was helpless. The wireless operator got to work, and on April 22nd established communication with the station at Cape Ray, where is located a high-power installation controlled by the Marconi Company. Cape Ray directed the s.s. *Sagona* to her assistance by means of her radio plant, and the latter vessel stood by the disabled ship pending the arrival of a salvage steamer. The ice in the Gulf was very heavy at the time, and there appeared to be a considerable doubt as to whether the *Lord Strathcona*, a salvage vessel belonging to the Quebec Company, would be able to get through to the *Benin*, and—in order to help her on her way—she was accompanied by the Canadian Government ice-breaker *Montcalm*; the Quebec Company and Messrs. Elder, Dempster & Company being in the meantime kept continuously posted as to the state of affairs through the wireless "plant" carried by their respective vessels. It soon became plain that, unless the conditions changed, it would be an impossible task for the *Lord Strathcona* to tow the *Benin* clear of the ice. The *Montcalm*, therefore, went scouting for open water and finally succeeded in finding clear "leads" to the southern shore of Anticosti. As soon as she reported to this effect, the necessary sailing directions were transmitted by wireless both to the *Benin* and the *Lord Strathcona*, with the result that the latter vessel undertook the task of towing the Elder Dempster liner from the Gulf up to Montreal. The salvage boat's first attempt to carry out these orders was unsuccessful. She beat her way fifteen miles into the ice after the *Benin*, only to find herself obliged to work laboriously out again under threat of the penalty of being overtaken by the same fate as had befallen the vessel she was attempting to rescue. Next she tried to worm through in the wake of the *Montcalm*; but although she followed that doughty ice-breaker at a distance of only 100 yards, the channel through the ice closed in again as fast as it was opened, and she was forced to give up the attempt. In the long run, the little ice-breaker *Fologo* went in with the *Montcalm* and struggled through the ice with the Elder Dempster liner in tow, the *Lord Strathcona* waiting for her outside. Connecting-up was effected in the midst of extremely heavy weather and a blinding snowstorm, and the violence of the pitching caused by the heavy weather may be indicated by the fact that it was judged advisable to supplement the brand new hawser employed, with 45 fathoms of the *Benin's* anchor-chain in order to eliminate risk of breakage. After these initial difficulties had been overcome all went well, and the thousand miles of towage were safely negotiated. The remarkable nature of the feat may be judged by the following figures: the weight of the vessel itself was 4,000 tons and she was carrying 6,000 tons of coal to Montreal.

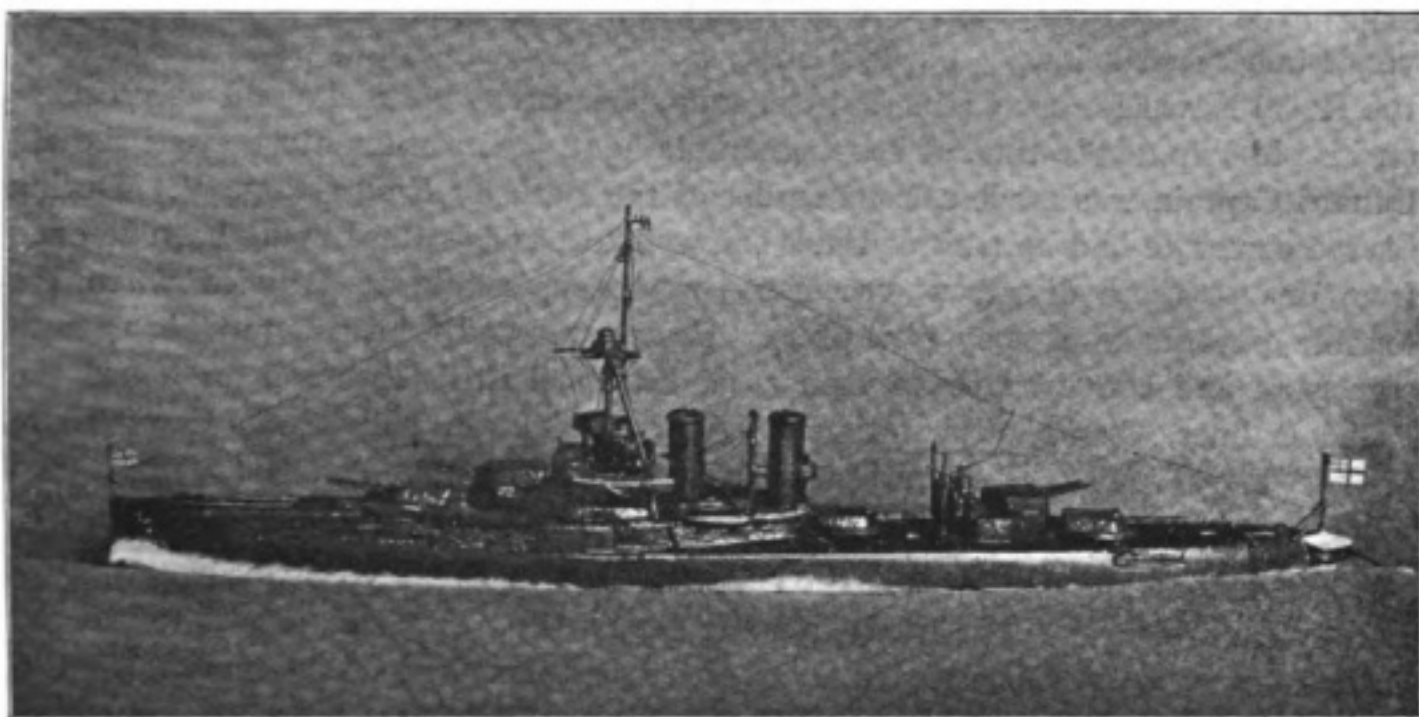

A MODEL WARSHIP MADE BY A WIRELESS OPERATOR FROM ODD MATERIALS
IN HIS SPARE TIME.

Ship and cargo were valued at over £100,000, and—in view of the 375 foot length of the *Benin*—it was found advisable to enlist the aid of Sincinnes-McNaughton's tug *Pratt* for steering through the reach which separates the Richelieu Rapids from Montreal.

It is not too much to say that the safety of the liner, her personnel, and her cargo was mainly due to wireless telegraphy, which summoned help when she was entangled in a hopeless position, which kept the authorities posted as to every move, and which maintained a close touch between all concerned throughout the long and arduous journey.

A "G.O.M." OF THE MERCANTILE MARINE.

There recently retired from the service of the Cunard Company Captain J. C. Barr, after 32 years' service and a most remarkable career. This announcement recalls a German Wireless Message despatched from Berlin on September 22nd, 1914, which runs :—

"With regard to the reported sinking of a German steamer by the British Auxiliary Cruiser *Carmania*, information to hand from the German side shows that the fight between the two vessels took place off the Brazilian Coast, and that the crew of the *Cap Trafalgar* was saved by the *Eleonore Woermann*."

The reference in this communication appertains to an interesting sea duel which took place off the East Coast of South America on September 14th, 1914. The *Carmania*, then under the command of Captain Noel Grant, R.N., sighted the Hamburg-American liner the *Cap Trafalgar*, accompanied by two colliers, and opened fire on her at 8,500 yards. The *Cap Trafalgar* was armed with eight 4-inch guns and put up a fight against the converted Cunarder which lasted one hour and forty-five minutes. Seventy-nine of their projectiles hit the *Carmania*, making 304 holes in her hull. Eventually the fight turned out in favour of the British and the German

vessel was "sent below." Captain Barr, who at the outbreak of war was not upon the Royal Naval Reserve, joined at the announcement of hostilities and was serving on his old ship at the time of her memorable fight. As a memento thereof the old Cunard Captain was made a Commander of the Bath by King George V. During his sea career he had been three times shipwrecked, and—after having been rescued from one of these disastrous occasions—was recuperating at Jamaica when the terrible earthquake of 1907 took place. He was rescued from this terrible natural cataclysm and conveyed to England as a distressed British seaman on board the R.M.S.P. liner *Moselle*, at that time in charge of Captain Jellicoe, the Commodore of the "Royal Mail" Fleet, and father of the famous British Admiral of to-day.

A SUGGESTED RIVAL TO "LLOYDS."

The unique shipping organisation known as "Lloyds" constitutes an "outward and visible sign" of British shipping supremacy. As such, it is naturally an object of envy to our German rivals, and at a recent meeting held in Hamburg at the beginning of June a project for the establishment of a German imitation was outlined by Dr. Brueders, of Berlin.

Wireless telegraphy already plays an important part in the organisation of signal stations, which forms one of the most important parts of the activities of Lloyds, and Dr. Brueders laid special emphasis upon its being essential that Germany should employ radio-telegraphy on a very much more extensive scale than does Great Britain, besides making herself independent as far as cables are concerned. The International position already held by this great British institution renders it hardly likely that the envious efforts of our Teutonic rivals will be likely to obtain any preference over it. Germany must surely recognise that the shipping interests of every country, neutrals included, have been alienated to no ordinary degree by their egregious policy of universal piracy. At the same time, forewarned is forearmed, and doubtless the managers of Lloyds will "make assurance doubly sure, and take a bond of fate."

Pastimes for Wireless Operators

UNDER the above title we have, as space permits from time to time, indicated to wireless operators afloat various ways in which their time off duty might be profitably employed. Our pages have contained, in this connection, hints with regard to Photography, Sketching, Banjo-playing, Study, etc., and we are happy to understand that our efforts in this direction are not without fruit. Readers will observe that on the preceding page we print an illustration depicting a model of a warship constructed by a wireless operator from odd materials in his spare time. We have seen the models, and one or two specimens have been very kindly left in our hands by the operator in question. He is plainly a young man of a very versatile turn, for, having been recently torpedoed, he was good enough to send us a well-composed and racy account of his adventures, which was duly "blue pencilled" out of existence by the Press Censor! Over and above this, he let us have some water-colour sketches which we should have been pleased to use, but which were reft from us by the same authoritative hand. In view of the fact that our comment is perforce nothing but laudatory, we think it well to spare his blushes by veiling his identity.



THE PURGING OF AFRICA

ONE of the powerful German long-distance stations, erected during pre-war days as part of their world-girdle, was situated at Monrovia, the capital city of the Independent African Republic of Liberia. This interesting negro community owes its origin to the desire on the part of the American Colonisation Society to establish a native republic in Africa based on the U.S.A. model. Its territories comprise 350 miles of the coastline of North Guinea, and stretch inland for 150 miles, whilst its population is estimated at 1,500,000. Of these, only about 10,000 are liberated American slaves and their descendants; the larger proportion by far being indigenous natives. No white man is allowed to acquire citizens' rights or to hold property.

Both the German and the French radio-telegraphic stations at Monrovia were dismantled at the start of the war, but, now that Liberia has followed the example of the U.S.A. and ended her neutrality, it appears likely that the latter (French) station will be reinstated.

The falling into line of Liberia is interesting, if only on account of the fact that, with the exception of an odd corner or so of what was once German East Africa, the whole "Dark Continent" is now purged of the Teutonic "Influence," on which our enemies at one time based such ambitious schemes.

A USEFUL POPULAR TREATISE.

The twenty-first anniversary of Wireless Telegraphy, which occurred on June 2 last, and was celebrated in our previous issue, sent men's minds travelling back to the early days of the science, and amongst the names which naturally recurred to our recollection was that of Augusto Righi, the Bologna scientist, under whose auspices the young Marconi studied electrical phenomena in his early days. Though born as long ago as 1850, this veteran is still with us, and the *American Physical Review* of May devotes a leading place to a detailed monograph on the "Magnetic Rays, Oscillations in the Geissler Tube and the Periodic Interruption of Spark Discharges," upon which Professor Righi bases a theory which apparently attracts more attention "on the other side" of the Atlantic than it does here. The perusal of this article reminds us that the extension of a chapter contained in Righi's "Telegraphia senza Filo" (wireless telegraphy) resulted in the publication of a capital little volume wherein (under the title of "The Modern Theory of Physical Phenomena") the Italian investigator put forward a work which in the words of Mr. A. Trowbridge, the translator, was "written more with the object of interesting the greatest possible number of readers . . . than as a book of reference for physicists."

It contains a lucid and popular account of the theory of the resolution of electricity into its component ions, passes in rapid review the occurrence of electrons in the cathode rays, and details the basic experiments which point to the "existence" of masses which are much smaller than that of the smallest atoms of any known "substances." The volume, published by Macmillan at 5s., forms one of those treatises which, requiring but a small amount of technical knowledge, contain a summary of an important phase of modern science extremely useful to the general reader.

PROGRESS AT SOUTH SHIELDS.

We learn that an instructional wireless apparatus has recently been erected at the marine school in South Shields, whose Principal, Mr. H. R. Cullen, is doing much to maintain and extend the development of the institution which he directs and to widen its sphere of influence in the light of modern requirements.

AN AIRMAN RESCUED BY WIRELESS.

Flying does not always depend for its "thrills" upon its connection with war. A skilled airman recently made an ascent from a certain Flying School on the British coast, and had attained the height of 2,000 feet when one of the wheels was observed to drop off his machine. The watchers below tried to call his attention to this accident, which, it was feared, would render it impossible for him to make a safe landing ashore. Failing in their essays to establish communication by means of flash signals, they had recourse to wireless, eventually succeeded in getting into touch with him and suggested that he should "land" in the sea. He preferred, however, to take his chances on *terra firma*, and was able to select an alighting place smooth enough to enable him (by clever manipulation of his steering apparatus) to come to earth with the whole weight thrown upon the single wheel which remained. After a few yards, however, the planes heeled over, the exposed axle buried itself in the earth, and the two flyers turned a complete somersault with their machine, and were found buried beneath the wreck.

Fortunately, as it turned out, they escaped with a shaking; and certainly owe their life to the wireless warning they received and to the skill which enabled them to take advantage of the knowledge imparted to them through the means of their aerial.

LIVELY TIMES IN SPAIN.

According to the recent accounts published in the French papers, secret wireless stations, and espionage generally, are as active as ever in the neighbourhood of Barcelona, the charming Iberian city which has been a centre of German activities ever since the beginning of the war. We believe that the Spanish authorities and police do their best to administer the regulations, especially framed by their Government in the interests of neutrality; but as fast as they detect and destroy one installation another rises in its place! The *Temps* correspondent even goes so far as to report that "during the night rockets are often seen rising from near the port, giving information to the U-boats."

Our Gallic contemporaries narrate in circumstantial detail the various incendiary methods employed by the Germans and their agents. They tell us, for instance,

that often, when fraternising in wine shops with their Teutonic "comrades," the Spanish workmen have small squares of explosives slipped into their pockets, which burst into flame after their unwary possessors return to work. On other occasions rags impregnated with inflammatory material are found, scattered about by the same kindly hands, within the area of munition establishments.

If only half the stories told by the French correspondents are true, our Iberian friends must be having a lively time indeed, thanks to the activities of their "guests"!

WIRELESS BALLOTING.

British Colonials have always been more "advanced" than the rest of us at home. Whilst the franchise proposals at present before the Parliament at Westminster provide very sparingly for bestowing votes upon our gallant fighters (a distinguished contemporary puts the figures at about 5 per cent.) our Australian cousins-in-arms are not only already in the possession of votes, but were, during their recent Federal Elections, afforded every opportunity of recording them, despite all the obstacles imposed by the voters' absence on active service.

It is estimated that about 6,000 men of the Australian fleet alone were enabled to record their votes, arrangements being made to enable them to do so, through the medium of wireless telegraphy. Balloting by wireless introduces a novel feature into electoral machinery, and constitutes a fresh example of the way in which this newly applied science is tending to permeate every phase of modern activity.

It is assuredly not without significance that, whilst the home authorities sit down and lament the difficulties of getting at voters on active service, the Australians, some hundreds of thousands of miles further away, set to work and *do it*, enlisting for that purpose every resource of modern civilisation, including wireless telegraphy and its ether waves.

The articles of Lieutenant Hoyle (see pages 264 to 266) have now come to an end and we are sure that they will have appealed to a very wide circle of our readers. Ranging as they do over an extended area of technical detail, we have little doubt that there are points on which some of our friends may possibly have opinions somewhat differing from those of our distinguished contributor. If this be the case, we shall be glad to hear from any critics whose qualifications may entitle them to express an opinion on the points at issue.

Share Market Report

London, June 13th, 1917.

BUSINESS has been very active in the shares of the various Marconi issues during the past month. There has been a large demand for shares, and the prices show a very marked improvement. The demand still continues as we go to Press, the closing prices being: Marconi ordinary, £3 5s. 7½d.; Marconi preference, £2 13s. 9d. Marconi International Marine, £2 8s. 9d.; American Marconi, 16s.; Canadian Marconi, 10s. 6d.; Spanish and General Wireless Trust, 9s. 6d.

An Outline of the Design of a Wireless Station

By BERTRAM HOYLE, M.Sc.Tech., A.M.I.E.E., Lieut. R.N.V.R.,
H.M.S. "Excellent," 1917.

(Continued from page 207 of our June issue)

22. *Secondary Oscillatory Circuit Considerations.*—The values of L and K chosen, depend on the nature of the detector employed. Thus, with a magnetic detector a larger value of K would be chosen than if crystal detectors were to be used.

In the present instance a large variable condenser will be designed, and the inductance steps so chosen that the wave-length limits overlap considerably. By this means it is often possible to receive any given wave on either of two inductance ranges; one using the high value of K_1 and the other using the small value of K_1 .

The high value of K_1 is best suited for the magnetic detector, and thermal detectors of the barretter type; whilst the smaller capacity is best suited for crystal detectors, vacuum valve and electrolytic detectors.

For working Einthoven string galvanometers for giving photographic records of stations sending with high-speed automatic transmitters, the rectifying valve, or crystal detector is used, and therefore a small K_1 .

23. *Detector Circuit Variable Condenser K_1 .*—The construction employed will be thin sheet zinc electrodes moving between other zinc sheets, the two systems being insulated from one another by thin ebonite sheet.

Let maximum capacity = 0.01 mfd.

and minimum capacity = 0.0002 mfd.

A working minimum may be taken as 0.0005 mfd., to allow for slight adjustment either way when using it.

$$\text{Capacity} = \frac{(N-1) A \times \text{S.I.C.}}{4 \pi t \times 9 \times 10^5} \text{ mfd.}$$

where N = number of metal plates:

$$\frac{N+1}{2} \text{ fixed, and } \frac{N-1}{2} \text{ moving.}$$

A = active area of one plate in square centimetres.

t = thickness of dielectric in centimetres.

Let $r_1 = 1$ cm. $r_2 = 5$ cm.

$$\therefore A = \pi (5^2 - 1^2) = 24 \pi = 75.5 \text{ sq. cms.}$$

Using ebonite of S.I.C. of 2.2:

Let $t = 0.1$ cm.

$$\begin{aligned} \text{Then } (N-1) &= \frac{0.01 \times 4 \pi \times 0.1 \times 9 \times 10^5}{75.5 \times 2.2} \\ &= 68.5 \end{aligned}$$

Let $N = 69$

$$\frac{69+1}{2} = 35 \text{ fixed, and } \frac{69-1}{2} = 34 \text{ moving.}$$

$K_{s \text{ max.}}$ will now be 0.01 mfd., and with accurately cut and mounted plates a minimum of 0.0002 mfd. should be reached.

24. *Receiver Oscillatory Inductance, L_s .*—This coil is mechanically constructed to allow of variable coupling with the small fixed portion of the aerial circuit inductance. It will be made with four tappings.

Since the change of capacity, over a working range, is from 0.01 to 0.0005 mfd., or 20 to 1, it follows that for any given inductance step the ratio of the greatest to smallest wave-length will be $\sqrt{20}$ to $\sqrt{1}$, or 4.47 to 1.

It now remains to choose the four wave-length ranges and find each appropriate inductance using the formula :

$$L = \frac{\lambda^2}{59.6^2 \times K}$$

where L and K are both either maximum values or both minimum values :

λ 1st range :	300 — 1,332 m.	$L_{T1} =$	50,000 cms.
λ 2nd range :	600 — 2,665 m.	$L_{T2} =$	200,000 cms.
λ 3rd range :	1000 — 4,420 m.	$L_{T3} =$	555,000 cms.
λ 4th range :	2494 — 11,000 m.	$L_{T4} =$	3,405,000 cms.

The fourth step of the inductance is very large if the same kind of wire is used throughout the coil: but for the example this will be done for simplicity of illustration.

The value of (a), the coil radius, will be taken at 6 cms., and will be constant. Wire taken at 8 turns per centimetre :

$\frac{d}{D}$ taken as 0.90; whence $A = 0.451$. This also is constant.

L_{T1} $a = 6$ cms. ; $b = 2$ cms. $\therefore n = 16$.
 $\frac{2a}{b} = 6$. $Q = 33.5$.
 $L_s = an^2 Q$.
 $= 6 \times 16^2 \times 33.5 = 51,500$ cms.
 $\Delta L = 4\pi an(A + B)$
 $= 4\pi \times 6 \times 16(0.639) = 770$ cms.
 True $L = L_s - \Delta L = 50,730$ cms.

L_{T2} Make $b = 4.8$ cms. $\therefore n = 38$.
 $L_s = 6 \times 38^2 \times 23.277 = 202,000$ cms.
 $\Delta L = 4\pi \times 6 \times 38 \times 0.7647 = 2,213$ cms.
 True $L = L_s - \Delta L = 199,800$ cms.

L_{T3} Make $b = 9.625$ cms. $\therefore n = 77$.
 $L_s = 6 \times 77^2 \times 15.678 = 558,500$ cms.
 $\Delta L = 4\pi \times 6 \times 77 \times 0.776 = 4,500$ cms.
 True $L = L_s - \Delta L = 554,000$ cms.

L_{T4} Make $b = 42$ cms. $\therefore n = 336$.
 $L_s = 6 \times 336^2 \times 4.961 = 3,365,000$ cms.
 $\Delta L = 4\pi \times 6 \times 336 \times 0.7855 = 19,900$ cms.
 True $L = L_s - \Delta L = 3,345,000$ cms. approx.

[NOTE.— $b = 45$ cms. $n = 360$, gives $L = 3,674,000$ cms.]

As was mentioned above, a modified fourth inductance range would be used in order to keep down the dimensions of the coil ; which, as it stands now, is excessive. One plan would be to wind the fourth range concentric with 1, 2, and 3, and then if $L_{1,2,3}$ be the inductance of the first three ranges (say L_A) and L_4 be the inductance of the fourth step by itself considered as a separate cylindrical coil, then the inductance of the four sections all in series will be

$$L \text{ total} = L_A + L_4 \pm 2 M_{A,4}$$

the sign depending on which way the fourth coil is connected up ; $M_{A,4}$ being the mutual inductance of the A coils on the B or *vice versa*.

The predetermination of such a complex total would probably be more trouble than it was worth ; and in an actual case a small model would be made and experiments made with different numbers of turns in order to obtain the correct total inductance.

CONCLUSION.

The salient features of the station have now been set forth. An actual station of the size taken in this example is decidedly more complicated, and there are many more details to be thought out and designed than have been mentioned in the above.

For example, probably a plain coupled tuner receiver would not be employed ; and in its stead, some form of multiple tuner with extended wave-length ranges would be installed.

Descriptions of large power stations, notably that at Arlington (*see* December, 1916, issue) will assist the reader in filling in the subsidiary details.

An Ether-Wave Impertinence

Yet a Fresh Indication of German Ignorance of National Psychology

A SHORT while ago the Russian Council of Workmen and Soldiers' Delegates addressed an appeal to the loyalty of the Russian Army, in which they stated that the Commander-in-Chief of the German armies on the Eastern Front sent to the Muscovite troops a wireless message purporting to indicate to them the way towards an honourable peace, and the means of ceasing to wage war, without a rupture with the Allies. In other words, the German High Command endeavoured to use radiotelegraphy for a purpose which would have brought immediate and condign punishment in old days, when such messages had to be sent into enemy lines under the protection of a flag of truce. Our readers will doubtless remember that Sir Walter Scott, in his *Old Mortality*, narrates an instance showing the treatment meted out to combatants who endeavoured to seduce the soldiers opposed to them in this fashion. Of course, it requires very little judgment to perceive that the suggestion is that the Russians should betray their friends for the benefit of their enemies and the salvation of their own skins. It goes to prove once again the intense ignorance of the Teutonic mind as to the psychology of peoples other than their own. The Russians are idealists, and the insidious suggestion made in this wireless message was treated by them with the scorn which it deserved. No flag of truce could avail to protect the bearer of such a message, which loses nothing of its despicable character by being conveyed through the medium of ether-waves.

A Note on ERRORS IN IRON-CORED HIGH- FREQUENCY CURRENT TRANS- FORMERS

By N. W. McLACHLAN, D.Sc.Eng., A.M.I.E.E.

THE author has already shown * that the percentage error in the transformation ratio of an iron-cored high-frequency current transformer is given by

$$e = 100 \left[\left\{ 1 + \frac{2Z_2 \cos \theta}{\omega L_2} + \frac{Z_2^2}{\omega^2 L_2^2} \right\}^{\frac{1}{2}} - 1 \right] \quad (1)$$

For small errors (5 per cent. or less) the term $\frac{Z_2^2}{\omega^2 L_2^2}$ can be neglected and the expression reduces to :

$$e \doteq \frac{100 Z_2 \cos \theta}{\omega L_2} \quad (2)$$

In Equation (2), if $\cos \theta$ †, ω and L_2 remain constant while Z_2 increases, the equation is linear and of the form $y = mx$. Thus when these conditions hold, the error is proportional to the impedance of the secondary circuit. If the frequency is constant, the apparent permeability and θ_1 are practically constant at low flux density. Hence ωL_2 is constant. Consider first the case in which the resistance in the secondary circuit is large in comparison with the reactance. If the apparent permeability is constant the percentage leakage flux may be assumed to remain constant as the flux density increases. The main flux, and therefore the leakage flux, is proportional to the secondary e.m.f. Moreover these fluxes and also the leakage inductance are approximately proportional to the resistance. Since $\theta_2 = \tan^{-1} \frac{\omega L_2^1}{R_2}$ and $L_2^1 \propto R_2$, it follows that θ_2 is constant at a given frequency. Hence, as the resistance in the secondary circuit is increased, $\cos (\theta_1 - \theta_2)$ and therefore $\frac{\cos \theta}{\omega L_2}$ remains practically unaltered, and the relationship between e and Z_2 is a linear one.

When R_2 is small and the reactance of the secondary circuit is gradually increased by inserting inductance (the error being small and the frequency constant) the value of θ_2 increases with the inductance and therefore with Z_2 . If $\theta_1 > \theta_2$, before the insertion of inductance, then $\cos (\theta_1 - \theta_2)$ increases with the inductance until $\theta_1 = \theta_2$, when it is unity; for larger inductances θ_2 increases and $\cos (\theta_1 - \theta_2)$ decreases. Thus if $e = aZ_2$, the value of a increases with Z_2 up to a certain point and then decreases. This would give rise to a point of inflexion on the curve showing the relation between e and Z_2 . In practice, however, the point of inflexion would be very difficult to obtain, since it occurs when the error is very small, and is therefore difficult to measure accurately.

* *Electrician*, Vol. 78, p. 382, 1916.

† $\cos \theta = \cos (\theta_1 - \theta_2)$ where θ_1 is the angle between I_1 and I_2 (see author's paper *loc. cit.*), and θ_2 is the angle of lag of the secondary current.

Equation (2) may be applied for errors of 5 per cent. or less, but for errors greater than this equation (1) must be used. This equation may be put in the form $e = 100 \left[\left\{ 1 + aZ_2 + bZ_2^2 \right\}^{\frac{1}{2}} - 1 \right]$ where $a = \frac{2 \cos \theta}{\omega L_2}$ and $b = \frac{1}{\omega^2 L_2^2}$. When Z_2 is large and is due chiefly to resistance, a and b diminish as the error and Z_2 increase. This decrease in a and b is due to the larger flux density. Although the apparent permeability is constant at very low flux densities, there is a point at which it begins to increase appreciably—i.e., when Z_2 , and therefore the error, is large. Moreover, under these conditions a and b being inversely proportional to the apparent permeability, will decrease, and the $e - Z_2$ curve will become convex upwards.

When Z_2 is mainly due to reactance, the curve takes almost the same shape as indicated above.

In order to test the validity of the preceding analysis, some experiments were carried out on a current transformer, particulars of which are as follows :

- Core = 0.47mm. Stalloy discs
- $L_2 = 9.5 \times 10^{-4}$ henry
- $n_2/n_1 = 50$
- $f = 2 \times 10^5 \sim$ per sec.
- Primary Current = 3.5 amperes

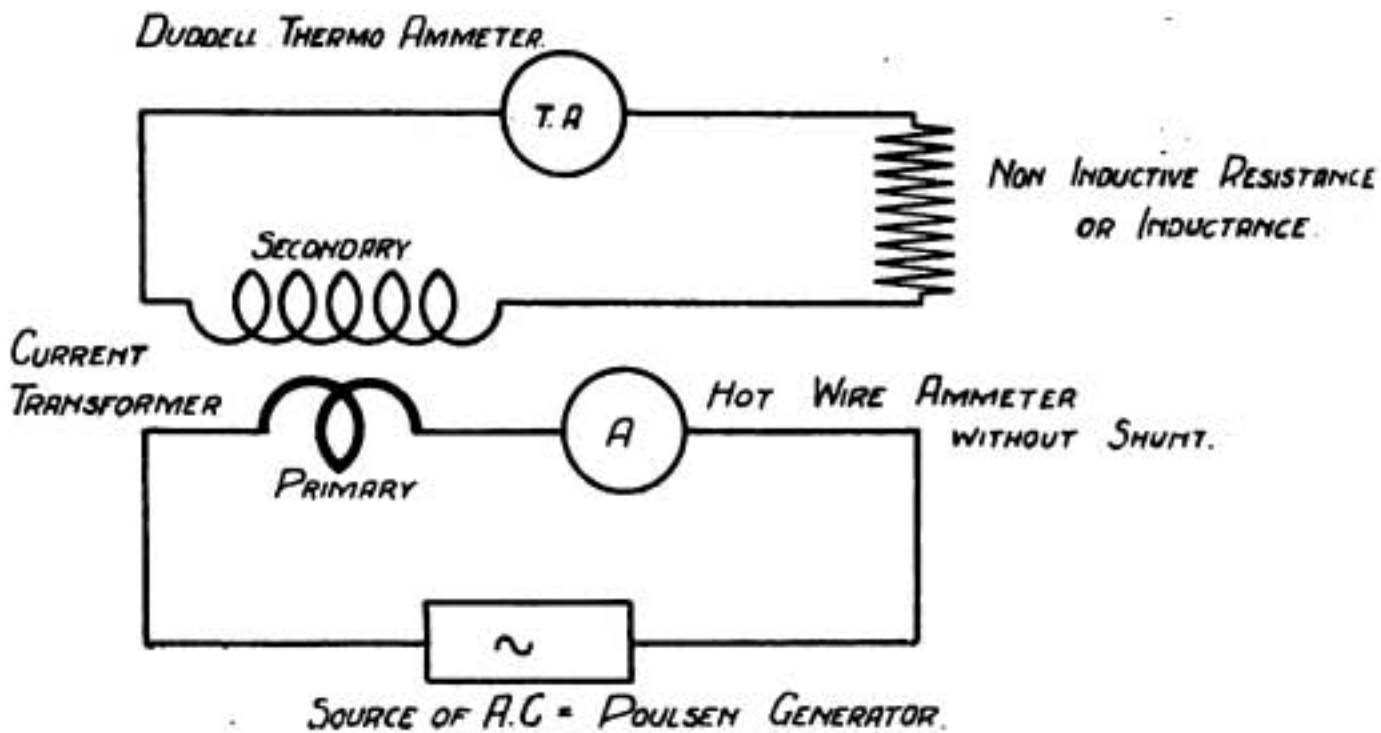

FIG. I.

ARRANGEMENT OF APPARATUS FOR DETERMINING THE ERROR IN THE TRANSFORMATION RATIO OF A CURRENT TRANSFORMER DUE TO RESISTANCE OR INDUCTANCE IN THE SECONDARY CIRCUIT.

The apparatus was arranged as shown in Fig. 1 (above).

The hot-wire ammeter was calibrated against the current transformer under normal conditions. A non-inductive resistance of fine manganin wire was inserted in series with the thermo-ammeter and simultaneous readings taken of T.A. and A. In

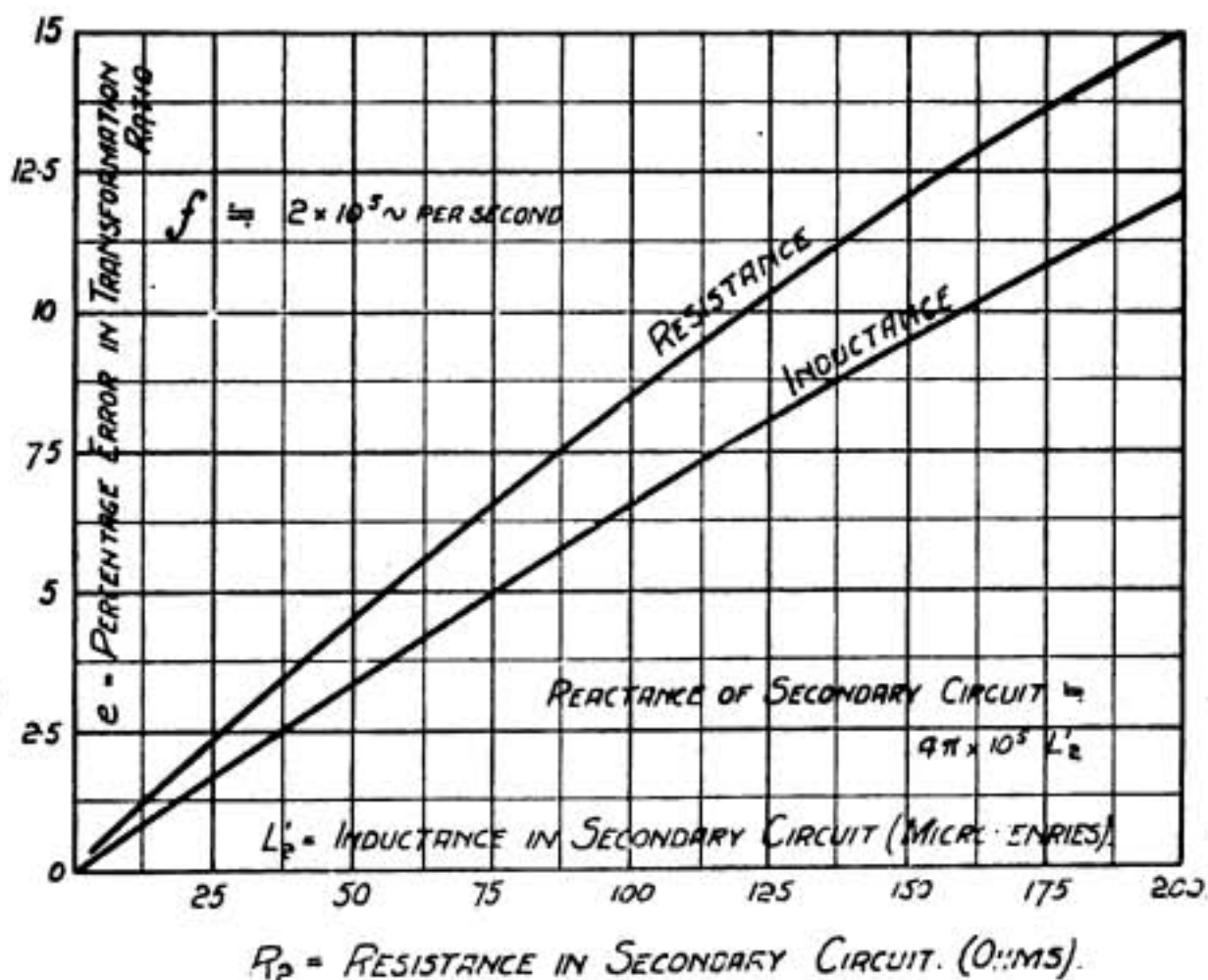

FIG. 2.

CURVES SHOWING THE RELATION BETWEEN THE PERCENTAGE ERROR IN THE TRANSFORMATION RATIO AND (1) THE RESISTANCE IN THE SECONDARY CIRCUIT, (2) THE INDUCTANCE IN THE SECONDARY CIRCUIT, AT A GIVEN FREQUENCY.

this way the errors corresponding to different resistances were found. An inductance of thick copper wire was then inserted in place of the resistance and the errors corresponding to different inductances found. The values of the inductance were measured at 500 ~ per sec. by means of a Campbell Variable Mutual Standard and a Duddell vibration galvanometer, the current wave being sinusoidal. In carrying out the tests to ascertain the errors, the magnitude of the capacity in the shunt circuit of the Poulsen generator was such that there were no higher harmonics in the current wave.

The results of the experiments are shown graphically in Fig. 2.* The curves are of the same form as those deduced from theoretical considerations. Although the curves have been plotted with resistance and inductance respectively as bases, they do not differ much from those which would have been obtained with impedance as base. There would be a slight difference in the portions near the origin, since the impedance of the secondary circuit is slightly greater than the pure resistance or pure reactance. In the first case this is due to leakage reactance, and in the second to the resistance of the circuit. For large resistances or reactances, the curves would not differ appreciably. Owing to the difficulty of measuring small errors accurately, the difference between the curves lies within the limits of experimental error.

* Allowance has been made for the small error when the transformer is working under normal conditions.

The curves in Fig. 2 show clearly that a large resistance or inductance is required in the secondary circuit to produce a small error in the transformation ratio. It is of interest to compare the error corresponding to a certain resistance with that corresponding to a reactance of equal magnitude. Taking a resistance of 50 ohms, the error is 3.9 per cent., whilst with a reactance of 50 ohms it is 2.7 per cent. Referring to equation (2), $Z_2/\omega L_2$ and θ_2 are practically the same in both cases, but θ_1 is much greater with reactance than with resistance in the secondary circuit. Hence $\cos \theta (= \cos (\theta_1 - \theta_2))$ is larger in the first case than in the second. This does not necessarily hold for very small errors, since the curve showing the relation between the percentage error and the inductance may have a point of inflexion in the neighbourhood of the origin (see above).

Merchant Seamen and the "Badge" Fashion

THE "Badge" fashion is growing upon us. We have ceased to be entities nowadays, we are merely becoming so many badge-wearers. There is the Regimental Badge, the Silver War Badge, the National Service Badge, the Badge of the Industrial Army, but by some queer kink in the arrangement of things we have, so far, no badge for the Mercantile Marine.

When the Government proposed a scheme at least twelve months ago for the issue of silver war badges to men who were invalided out of the Navy and Army, it was decided to include the officers and men who were serving under special naval engagements in His Majesty's ships and auxiliaries. This application of the scheme, of course, ignored the officers and men engaged in the overseas trade of the Mercantile Marine, many of whom have had to relinquish their employment altogether owing to wounds or injuries, or arising as a direct result of war conditions.

It is such a little thing that is being asked—such a big thing that these men are doing. They are daily made the target of shell fire from enemy craft; they are liable at any moment to be turned adrift in open boats in mid-ocean to perish from cold, hunger or thirst; they have to face storm and tempest in ships packed with ammunition and high explosives, when every accident may court disaster, and to navigate minefields and rockbound coasts with all lights and beacons extinguished on the shore. And when, wounded or ill, or suffering from nervous breakdown, they reluctantly relinquish their duties—how do we express our gratitude?

The Mercantile Marine Service Association has been for some time urging the Government that when framing the rules they would take the opportunity of recognising the exceptional services of the whole of the Mercantile Marine during the war and award silver badges to officers and men of merchant vessels who, through wounds and sickness caused by the war, have been compelled to retire from active service.

Considerable correspondence has ensued upon this subject, but as yet there appears no prospect of an early settlement; the most recent communication received by the Secretary of the Mercantile Marine Service Association from the Board of Trade states that whilst the Board of Trade has been "in communication with the Admiralty and War Office on the subject, no final decision has been reached."

Among the Operators

S.S. "TRANSYLVANIA."

THE torpedoing of the transport *Transylvania* will still be fresh in the memory of our readers. On this vessel three operators were carried—Messrs. W. R. Bain, F. A. Webb, and L. C. Matthews. Fortunately all three figure among the saved.



OPERATOR W. R. BAIN.

Mr. William Robert Bain, the senior operator, is a Scotsman hailing from Tain, in the county of Ross. He is twenty-eight years of age, and for six years was a student at the Glasgow Royal Technical College. On leaving this institution he entered the engineering profession in Glasgow, and later studied wireless telegraphy at the British School of Telegraphy, Clapham Road. In March, 1913, he entered the Marconi Company's London School, and was appointed to the s.s. *Cestrian* shortly afterwards, later transferring to the s.s. *Kelvinbank*. His appointment to the s.s. *Transylvania* dated from May, 1915, and he had thus served two years on this great vessel before she was torpedoed.

The second operator, Mr. Frank Augustus Webb, is a native of Worcestershire and is nineteen years of age. He was educated at Dudley, and after leaving school took up a commercial appointment in his native town. He later joined the staff of the Post Office as a telegraphist. This appointment he gave up for the purpose of joining the Marconi Company in May, 1916, and on completing his training at Marconi House School was appointed to the s.s. *Transylvania*, where he remained until she was sunk.

The third operator, Mr. Leonard Cyril Matthews, is seventeen years of age, and was born at Hackney. On leaving school he entered the services of the South Eastern and Chatham Railway, and later joined the Messengers' Staff of Marconi's Wireless Telegraph Co., Ltd. Whilst holding this position he attended evening classes at the Marconi House School, and joined the operating staff in February of this year. The *Transylvania* was his first ship.

We congratulate all three men upon their lucky escape.



OPERATOR F. A. WEBB.



OPERATOR L. C. MATTHEWS.

London School in February of 1914, and two months later was appointed to the s.s. *Goorkha*, where he served for several trips. Afterwards he served on a number of other vessels, and was appointed to the *Dover Castle* in August of last year.

Mr. Durrant, the junior operator, is a Gorleston man, and is nineteen years old. He received his education in Gorleston, and being a very keen boy scout was later appointed patrol leader in charge of scouts at one of His Majesty's naval bases. Having the ambition to become a wireless operator, he studied in his spare time, and joined the Marconi Company's School in February, 1916. After training at Marconi House, he



OPERATOR H. D. KENWORTHY.

ANOTHER HOSPITAL SHIP.

The hospital ship *Dover Castle*, whose loss was duly reported in the papers, carried Mr. Horace Douglas Kenworthy as senior operator and Cecil Harry Durrant as junior. Mr. Kenworthy, who is twenty-two years of age, was born near Chester, and received his education at Southport, Flixton and Urmston. On leaving school he took up an appointment in Manchester, and later was employed by the British Westinghouse Company of that city. After training in wireless at the Fallowfield Wireless Training College, Manchester, and obtaining his First-class Postmaster-General's Certificate, he joined the Marconi Company's



OPERATOR C. H. DURRANT.

was appointed to the s.s. *Durham Castle*, and after serving on two other vessels was appointed to the s.s. *Dover Castle* in December last. This is the second time Mr. Durrant has been torpedoed, and both men are to be heartily congratulated upon their fortunate escape.

* * * * *

MISSING.

It is with much regret that we have to announce that Operator Lionel John Briggs, a wireless operator on the Marine Staff of the Marconi Company, is reported missing after the wreck of his ship, and no hope is entertained of his being saved. Mr. Briggs, who was born

at Ballybrophy, Queen's County, was twenty-one years of age, and was educated by private tutors. Taking an interest in wireless telegraphy, he undertook a course of training at the Manchester College of Wireless Telegraphy, where he obtained his Postmaster-General's First-class Certificate. His engagement with the Marconi Company dates from just after the outbreak of war, and his first ship was the s.s. *Welshman*. After three trips on this vessel he transferred to the s.s. *Thorpe Grange*, and later to the s.s. *Walmer Castle*. He then served on two other vessels before his appointment to the last one on which he served.



THE LATE MR. L. J. BRIGGS.

Deep sympathy is felt for his mother in the terrible loss she has sustained.

The Great Transaction

To the Young Lost Wireless Operators

"The wireless operator, who remained at his post until the ship sank, was not seen again."—(Daily Paper).

LIFE, with the hope of living,
 Hope, in the quest of delight,
 Love, and the joy of giving,
 Knowledge, and clearness of sight,
 Travail seasoned with laughter,
 Labour with due meed of gain.
 Wisdom and Honour thereafter,
 Pride of the hand and the brain,
 These were the things they offered,—
 All that they had to give.
 They grasped at the cup duty prof-
 fered,
 They would not shame us—and live.
 With faint sounds in their ears of the
 trumpets that blow on the other
 side,

They made the exchange. Like a sword
 fell the high will of God—and they
 died.

* * * *

Scarce had they learned to live
 Or see before them ;
 Nor long had dropped the hands
 Of those who bore them ;
 Yet there were magic words,
 Honour and Duty,
 In which they read full well
 Meaning and beauty.
 Youths of heroic strain,
 Danger defying,
 Pressing toward the mark,
 Touched it in dying.

Graphical Methods

By J. A. TOMKINS

THIS article is intended to supplement one by Mr. S. Lowey in *THE WIRELESS WORLD*, March, 1917 (page 942), in which was given a geometrical method for solving problems on resistances or inductances in parallel and capacities in series. The method described by Mr. Lowey appeared some years ago in the *Elektrotechnische Zeitschrift*, from which it was reproduced a little later by *Le Génie Civil*, May 2, 1891, and introduced into this country by the *Electrician*, December 18th, 1891.

In the first place, it may be noted that the lines AB , CD , EF , etc. (Fig. 1), representing resistances, etc., need not be perpendicular to the base line, AC , though this is obviously the most convenient construction. The method holds if the lines are drawn parallel to one another whatever angle they make with CD .

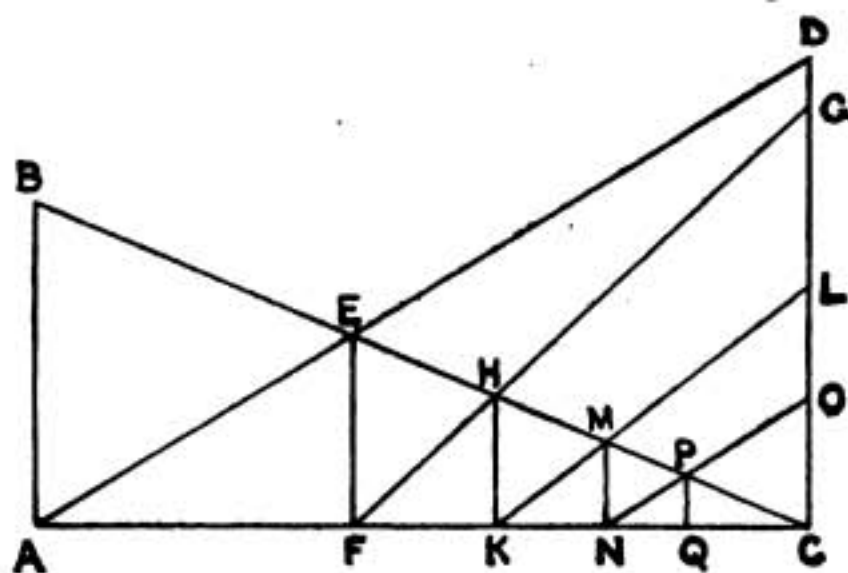

FIG. 1.

Further, in dealing with three or more quantities, Mr. Lowey's method may be considerably simplified by setting them all off, after the first, along the same line, CD , as shown in Fig. 1, which applies to five quantities. The construction is as follows:—

Set off AB , CD , CG , etc., representing the five quantities to scale. Join BC and AD intersecting in E . Drop perpendicular EF . Join FG . Drop perpendicular HK , and so on. The last perpendicular, PQ , represents the required quantity. By this means the drawing of several lines is avoided.

Again, to find the quantity which must be combined with another in order to reduce its value to some given amount we may proceed in two ways:—

(1) Set off AB and EF (Fig. 1), representing to scale the given quantity and the final quantity respectively. Join BE and produce to meet AC in C . Draw CD perpendicular to AC . Draw AED , meeting CD in D . Then CD will represent the quantity required.

Or (2), using the formula for joint resistances, capacities, etc.:—

$$\frac{1}{r_1} + \frac{1}{r_2} = \frac{1}{R} \quad (1)$$

To find the value of r_2 which must be combined with r_1 to give R we have:—

$$\frac{1}{r_2} = \frac{1}{R} - \frac{1}{r_1} \quad (2)$$

Hence we set off AB (Fig. 2) to represent R and CD to represent r_1 , but in this case CD must be drawn *downwards* because the term $\frac{1}{r_1}$ is *negative*. Join CB , DA , produce to meet at E , and drop the perpendicular EF , which gives the required quantity.

An even simpler method, which is a modification of that just described, was given by *Le Génie Civil*, September 22nd, 1891. This method, however, was known, and had been used, in this country before that date for the graphical solution of optical problems.

It may be derived from the previous construction by making the horizontal line, AC (Fig. 1), equal to CD . Hence, in all cases, the angle CAD is 45° and the line AED therefore is fixed in direction. Thus E may be found without setting off CD and the perpendicular EF drawn. Hence the following construction:—

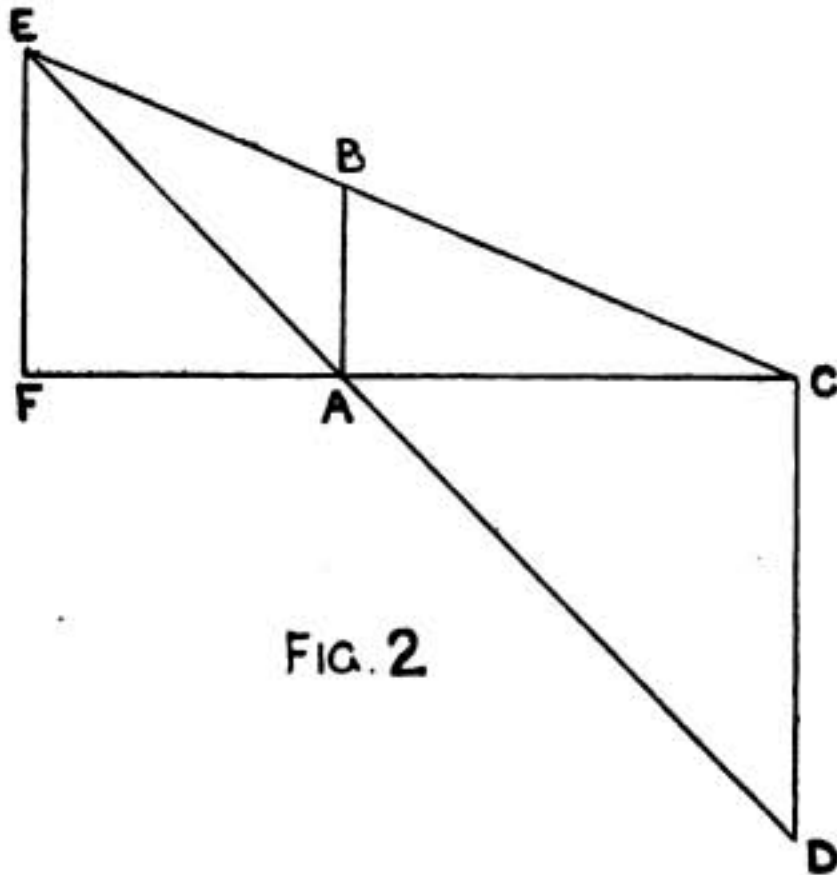

FIG. 2

Draw OA and OB at right angles to represent the two quantities and OC to bisect the angle, AOB . Join AB , intersecting OC in C , and from C

drop CD perpendicular to OA . Then CD or OD will give the quantity required.

It will be noted that in this construction there is one line less than in the previous method.

The reader will find it instructive also to derive this method from the *intercept form* of the equation of a straight line, viz. :—

$$\frac{x}{a} + \frac{y}{b} = 1 \quad \dots \quad (3)$$

(See Instructional Article, WIRELESS WORLD, July, 1916, page 319.)

where a and b are the intercepts on the axes of x and y .

If now we take any point (R, R) and draw a straight line through it, the relation between the intercepts on the axes for all positions of the line will be given by:—

$$\frac{R}{a} + \frac{R}{b} = 1$$

or $\frac{1}{a} + \frac{1}{b} = \frac{1}{R} \quad \dots \quad (4)$

which will be the same as (1) above if a and b represent r_1 and r_2 respectively.

This method may be easily extended to three or more quantities by combining CD with the third quantity. Thus, let OF (Fig. 3) represent the third quantity. On

OB set off $OE = CD$. Join EF intersecting OC in H . Drop the perpendicular HK , which will give the required quantity. And so on for any number of quantities.

The last method suggests a simple device which the writer has used for a number of years for rapidly solving problems of this kind and by means of which all drawing may be avoided with the exception of the one line OC , which is drawn once for all on a sheet of squared paper. It consists of a strip of clear celluloid twelve inches

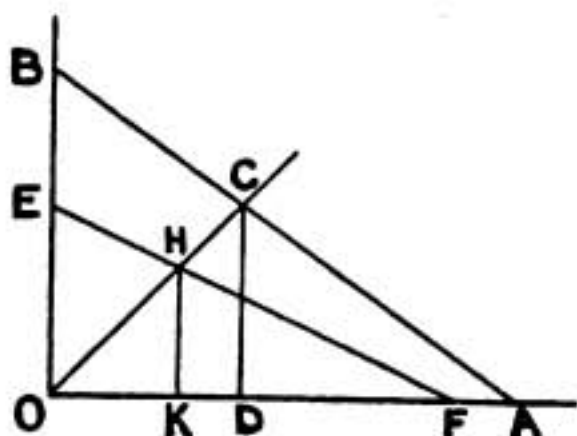

FIG. 3

or more long and one inch wide. On this, parallel to its length, a fine straight line is scratched, like that on the cursor of a slide-rule. In this line, at convenient intervals, are bored two or three small holes into which a drawing-pin will just fit and by means of which the strip can be pinned down on the sheet of squared paper.

By pinning the strip, line downwards, at points such as C or B (Fig. 3), turning the strip into the appropriate position, and reading off the point of intersection of the line on the strip with either OA or OC , as the case may be, the unknown quantity may be readily determined.

Such a device, on account of the fineness of the line, would probably be more convenient and accurate than either a stretched thread or straight-edge in connection with the "abacs" referred to in recent articles (WIRELESS WORLD, October, 1916, page 514; February, 1917, page 857; April, 1917, page 58.)

Finally, if drawing-pins are employed, as described above, in order to secure accuracy of position in pinning down the strip and to avoid unnecessary damage to the diagram by the perforation, it is well to select fine sharp-pointed pins. Those stamped out in one piece are not to be recommended.

Wireless as a Career

WE desire to call the attention of our readers to the advertisement inserted by the Marconi Company on page xx of our current issue. A number of young men, between the ages of $16\frac{1}{2}$ and 17 and nine months, are wanted for the purpose of receiving a training in wireless telegraphy, permanent employment being found for those applicants who, after going through a course of free instruction in the Marconi Company's own schools, attain the requisite standard of proficiency. The opportunity thus afforded is well worthy of consideration from the educational standpoint alone. We understand that candidates do not bind themselves for any long period; so that although, doubtless, the Marconi Company expect that a large proportion of the pupils will adopt radiotelegraphy as a permanent career, no young man need hesitate on the score of doubt as to his "natural bent," and no parent or guardian need hesitate lest he may be committing a youth under his charge to a career for which he may turn out later on to be unsuited. We need hardly point out, moreover, the excellent opportunity hereby afforded to young men under military age of serving their country and aiding to render abortive the submarine menace of our foes.



SIMULTANEOUSLY with the declaration of war by the United States came a complete reorganisation of the wireless industry in this country. Immediately upon declaration of war by Congress full authority was given by the President of the United States to the Navy Department for the mobilisation and complete control of all radio stations on land, or otherwise, coming under the jurisdiction of the United States.

The Navy Department has taken over all commercial radio shore stations, including high-power stations, and at present is operating a large number of these stations, the balance having been temporarily closed. All amateurs and experimenters in this country were ordered to dismantle their antennæ, and at present the transmission and reception of radio signals in all classes of service is directly under the supervision of the United States Navy.

Coincident with the above there have been placed by the United States Government large orders for radio equipments with the wireless manufacturing companies in this country, and all those capable of producing efficient radio equipments are working their plants to full capacity in order to meet the requirements of the Government.

A number of merchant vessels not previously equipped with any system of wireless communication at once realised the importance of carrying radio apparatus, and the shipyards and dry docks are at present busy places for wireless installation men.

It is not possible at this time to predict the ultimate effect of this tremendous growth of the wireless industry in so short a period of time, but it is a safe prediction that the war has given an impetus to the radio business, particularly in the manufacture and production of radio apparatus, that will unquestionably produce lasting and beneficial effects.

It is also a source of gratification that the radio manufacturing organisations and others producing apparatus closely allied with radio equipments have given prompt and patriotic response to the needs of the Government, and the enthusiasm with which the men of the radio profession are carrying their heavy but cheerful burdens of the present is a tribute to all those concerned with the art of radio communication.

The Board of Direction of the Institute of Radio Engineers has decided to award

E

annually a "Medal of Honour" to such persons who have distinguished themselves by unusual advances in the fields of radio-telegraphy and telephony. It has been felt that some way should be found whereby valuable work in these fields of great and rapidly growing importance might properly be recognised by an authoritative engineering society.

The medal is the work of the well-known sculptor, Edward Sanford, jr., of New York, and the award will be made yearly at the April meeting of the Institute to the person who during the two preceding calendar years shall have made public the greatest advance in the art of radio communication. The advance may be a patented or unpatented invention, but it must be completely and adequately described in a scientific or engineering publication of recognised standing and must be in actual, though not necessarily commercial, operation. However, preference is to be given to widely used and widely useful inventions.

The advance may also consist in a scientific analysis or explanation of hitherto unexplained phenomena of distinct importance to the radio art, although the application may not be immediate. Preference will be given to analyses directly applicable in the art. In this case also publication must be full and in approved form.

The advance, furthermore, may consist in a new system of traffic regulation or control, a new system of administration of radio companies or the radio service of steamship, railroad, or other companies, a legislative programme beneficial to the radio art, or any portion of the operating or regulating features of wireless. It must be described publicly in clear and approved form and must, in general, be actually adopted in practice. In all cases marked preference is to be given to advances made in the preceding year.

I am in a position to advise at this time that the first medal will be presented at the coming meeting of the Institute of Radio Engineers, to be held during the month of May, to Mr. Edwin H. Armstrong, the well-known research engineer of Columbia University. The medal is being awarded to Mr. Armstrong in recognition of the work he has done in connection with receiving apparatus which employs the Armstrong circuits, a contribution to the radio art considered by the Institute of Radio Engineers to be of the highest importance.

President Wilson's Wireless Order

THE following is the executive order issued by President Wilson relating to the closing of American amateur stations, on the declaration of war by the United States. It will be read with considerable interest by amateurs in this country :

" WHEREAS the Senate and House of Representatives of the United States of
" America, in Congress assembled, have declared that a state of war exists between
" the United States and the Imperial German Government ; and WHEREAS it
" is necessary to operate certain radio stations for radio communication by the
" Government and to close other radio stations not so operated, to insure the proper
" conduct of the war against the Imperial German Government and the successful

" termination thereof. NOW, therefore, it is ordered by virtue of authority vested
 " in me by the Act to Regulate Radio Communication, approved August 13, 1912,
 " that such radio stations within the jurisdiction of the United States as are required
 " for naval communications shall be taken over by the Government of the United
 " States and used and controlled by it, to the exclusion of any other control or use ;
 " and, furthermore, that all radio stations not necessary to the Government of the
 " United States for Naval Communications may be closed for radio com-
 " munication.

" The enforcement of this order is hereby delegated to the Secretary of the Navy,
 " who is authorised and directed to take such action in the premises as to him may
 " appear necessary.

" This order shall take effect from and after this date.

(Signed) WOODROW WILSON."

" The White House,

" April 6, 1917."

Marconi Co. *versus* De Forest Co.

RESULT OF APPEAL.

ON May 8th the Circuit Court of Appeals for the Second Circuit handed down a unanimous opinion in favour of the Marconi Wireless Telegraph Company of America in its suit brought against the De Forest Radio Telegraph and Telephone Company for infringement of the well-known Fleming patent.

The case was originally brought in the United States District Court of the Southern District of New York by the Marconi Company on this Fleming patent, alleging that the De Forest Company's so-called " Audion " was an infringement. The Defendant, the De Forest Company, set up a counter claim, alleging that the Marconi Company's apparatus infringed nine De Forest patents. In the trial court Judge Julius M. Mayer held that the Marconi Company's Fleming patent was a patent of great merit and of value, and was valid, and had been infringed by the De Forest " Audion " ; he also held that the Marconi Company's apparatus did not infringe seven patents of the De Forest Company. It was admitted that the two other De Forest patents were good patents, as being improvements on its Fleming patent.

In affirming the decree of Judge Mayer, Judge Hough, speaking for the Circuit Court of Appeals, said : " We have no doubt that Fleming's patent displays invention " and of a very meritorious device."

As to the patents which the De Forest Company alleged that the Marconi Company had been infringing, the Court of Appeals held that six of them were not infringed, and that a seventh was void.

The result, therefore, of this opinion indicates that the Marconi Company had the underlying or basic patent for what are called " vacuum valve " detectors, and that the De Forest Company has two patents for improvements on the basic Marconi Company's Fleming patent for these devices.

The Davis-Martin Wireless Slide Rule

A New Device for the Use of Practical Workers

WE illustrate on page 281 a new device for the use of wireless men entitled "The Davis-Martin Wireless Slide Rule." It is primarily designed for use in making calculations in wireless problems. The equation $\lambda = K \sqrt{L \times C}$ where λ = wave-length, L = inductance, C = capacity, and K a constant depending upon the units used is commonly used in all wireless calculations. The rule serves this equation where one or other of the factors is unknown. The special indicating arrows, M , M^1 , M^2 , M^3 , and F , F^1 , F^2 , and F^3 cover all equations in which the wave-length is in metres, or the inductance in centimetres or microhenries, and the capacity in centimetres, jars, or microfarads. It will be noticed that the sin, log, and tan scales on the ordinary slide rule have been replaced by the capacity scale and indicating arrows, but as these scales are very seldom, if ever, used by the practical man, who prefers tables, the substitution will be found a great advantage for all electrical engineers interested in wireless. The centre slide of this rule can be reversed so as to give an ordinary slide rule. The following instructions for the use of the instrument have been sent to us by Mr. A. J. Martin, the inventor, who has arranged with Messrs. John Davis & Son (Derby) Ltd., of All Saints, Derby, for its manufacture. The price of the rule complete in case is 11s. 6d.

INSTRUCTIONS.

General information.—Capacity : 1,000 cms. = 1 jar, 900,000 cms. = 1 microfarad, '001 microfarads = 1 jar.

Inductance : 1,000 cms. = 1 microhenry or "mic."

Arrow	Wave-length.	To obtain capacity in	The capacity scale reading should be	To obtain inductance in	The inductance scale reading should be
1 M^1	Metres	mids.	$\times 1$	cms.	$\div 1$
2 M^1	"	"	$\div 10$	"	$\div 1$
3 M^1	"	"	$\times 1$	"	$\div 10$
4 M^2	"	cms.	$\times 10^6$	"	$\div 1$
5 M^2	"	jars	$\times 10^3$	mics.	$\div 10^3$
6 M^2	"	cms.	$\times 10^6$	cms.	$\div 10$
7 M^2	"	jars	$\times 10^3$	mics.	$\div 10^3$
8 M^2	"	cms.	$\times 10^6$	cms.	$\times 1$
9 F	Feet	mids.	$\times 1$	"	$\times 1$
10 F^1	"	"	$\times 10$	"	$\div 1$
11 F^1	"	"	$\times 1$	"	$\div 10$
12 F^2	"	cms.	$\times 10^6$	"	$\div 1$
13 F^2	"	jars	$\times 10^3$	mics.	$\div 10^3$
14 F^2	"	cms.	$\times 10^6$	cms.	$\div 1$
15 F^2	"	cms.	$\times 10^6$	"	$\div 10$
16 F^2	"	jars	$\times 10^3$	mics.	$\div 10^3$
17 F^2	"	jars	$\times 10^3$	"	$\div 10^3$

If the wave-length scale is multiplied by any number such as 10, 100, 1,000, or 10,000, the product of the capacity and inductance should be multiplied by the

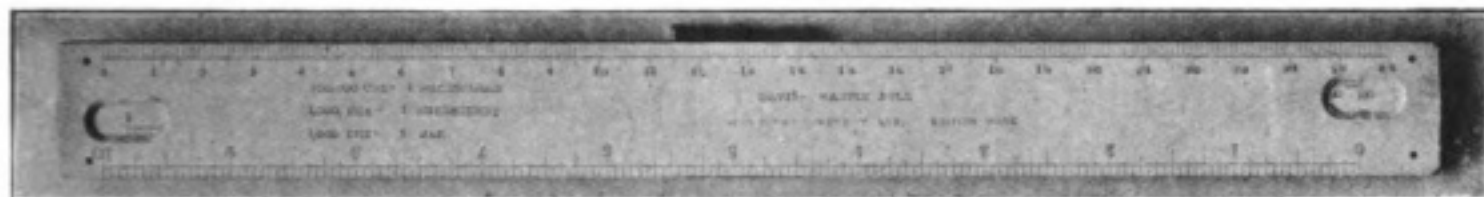

THE "DAVIS-MARTIN" WIRELESS SLIDE-RULE (BACK VIEW).

square of the number—*i.e.*, 100, 10,000, 1,000,000, or 100,000,000. The product of the inductance and capacity—*i.e.*, the L.S. or L.C. values—can be obtained by placing the arrow for the units required against the wave-length, and reading off the answer opposite K or K¹ on the inductance scale.

If the oscillation constant is required—*i.e.*, $\sqrt{L \times C}$, read off on wave-length scale opposite K and divide by 10, or opposite K¹ and divide by 100.

EXAMPLES.

1. Wave-length 400 metres. Capacity 0.002 mfd., find inductance in cms. Place arrow M against 400 on λ scale and opposite 0.002 on capacity scale, read off 2.26 on inductance scale. As the wave-length was multiplied by 100, the answer should be multiplied by 100², and therefore equals 22,600 cms.

2. Wave-length, 2,000 feet. Capacity, 18 jars. Find inductance in mics. Use line 13 in table. Place arrow F² against 2,000 feet and read off opposite 18 jars—*i.e.*, .0018 on the scale, the answer 5.25 multiply by 100 and we obtain 525 mics. By looking at line 13 in the table it will be seen that if the wave-length scale is multiplied by 1,000, we must multiply the product of the inductance and capacity scales by 1,000²; from this we obtain λ scale reading from 1,000 to 10,000 feet. Capacity scale reading from 1 to 100 jars and inductance scale reading from 100 to 10,000 mics.

3. Capacity 30 jars, inductance 860 mics. Find wave-length in feet. Place 8.60 against .003 and read off answer opposite F² which equals 3.3—*i.e.*, 3,300 feet.

All readers interested in wireless work will appreciate the help placed at their disposal by Mr. Martin's ingenious utilisation of the slide rule, and will, we are sure, hasten to add it to their outfit.

* * * * *

These aids to rapid and accurate calculation are every day lightening the task of wireless men in a way totally undreamed of by their predecessors. Tables of calculation and succinct formulæ are constantly appearing in the pages of this Magazine, and should form the subject of careful study in this connection. Dr. Eccles especially has done a great deal to assist practical workers by his various series of "abacs," which have been given to the world in the *Wireless Year Book* and in other publications. Mr. Samuel Lowey, Mr. Nottage and others constantly contribute similar material for technical workers, which we are always glad to publish for the benefit of our readers.

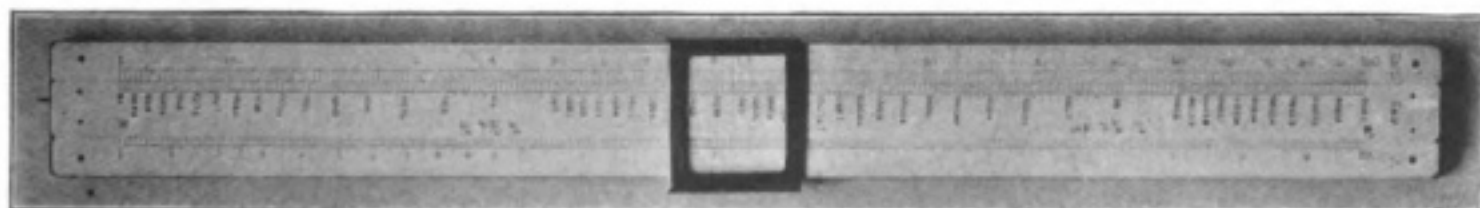

THE "DAVIS-MARTIN" WIRELESS SLIDE-RULE (FRONT VIEW).

Instructional Article

NEW SERIES (No. 4).

EDITORIAL NOTE.—In the opening number of the new volume we commenced a new series of valuable instructional articles dealing with *Alternating Current Working*. These articles, of which the present is the fourth, are being specially prepared by a wireless expert for wireless students, and will be found to be of great value to all who are interested in wireless telegraphy, either from the theoretical or practical point of view. They will also show the practical application of the instruction in mathematics given in the previous volume.

INDUCTANCE (continued).

19. Choking Coils.—The inductance of a coil without a magnetic core can be calculated from formulæ and depend principally on the geometric dimensions. Inductances used in low-frequency circuits, as in the primary circuit of a wireless telegraph set, are built up with soft iron cores. The inductance of a coil with a magnetic core will depend not only on the dimensions of the coil, but also on the physical properties of the core.

The magnetic state of iron varies with the current flowing round the coil, and, to a certain extent, the frequency.

The magnetising force in a coil is proportional to the current flowing round that coil. Call this magnetising force H ; then if B is the flux-density—that is the number of lines of magnetic force per square centimetre induced in the core—then

$$B = \mu H$$

where μ is the permeability of the iron core.

The value of μ is an indication of the magnetic state of the iron, and varies with H .

If a curve connecting H and B for any sample of iron be drawn that curve is known as a **Hysteresis** loop. (See Fig. 17.)

It will then be seen that B does not vary in proportion to H , and at one point when $H = 0$, $B = 5,700$, or when $-H = 0$, $-B = -5,700$. Therefore, when an alternating current flows round an inductance coil with an iron core, a complicated state is set up in the core. Also the permeability of the iron will vary over the area of cross-section of the core, since H is not constant over this area.

In designing inductance coils it is, therefore, only possible to take some average value found from experience or experiment.

In any coil

$$\text{Magnetic flux} = \frac{\text{Magneto motive force}}{\text{Magnetic resistance}}$$

The magnetic resistance is usually termed the **reluctance** and

$$= \frac{l}{A \mu}$$

where l = length of core in c.m.s, A its area of cross-section in c.m.s, and μ the permeability of the core. If the core is air, then $\mu = 1$.

In an inductance coil of length l c.m.s with n turns of wire per c.m., and with a current of C c.g.s. units flowing through it, the magnetic flux is $4\pi nC$ lines per square c.m. But each turn of wire of the coil will enclose this number of lines.

Therefore the inductance, L ,
 $= 4\pi n \times nl$ c.g.s. units
 $= 4\pi n^2 l$ c.g.s. units.

Now, if the coil of wire is wound on an iron core of cross-section A sq. c.m.s then the magnetic flux

$$= 4\pi nC \times A \mu \text{ lines.}$$

The inductance will then be

$$4\pi n^2 l \times A \mu \text{ c.g.s. units.}$$

If N = total number of turns

The inductance

$$= \frac{4\pi N^2 \times A \mu}{l} \text{ c.g.s. units.}$$

This formula is correct when the magnetic core forms a nearly closed circuit—that is, when there is a very small space between the ends of the core.

If, however, the core is what is called an "open" core, then the formula needs some modification.

It can be used by introducing a correction factor K , which factor has such a value found from experience or previous figures.

The formula then becomes

$$\text{Inductance} = \frac{4\pi N^2 A \mu}{l} \times K \text{ c.g.s. units.}$$

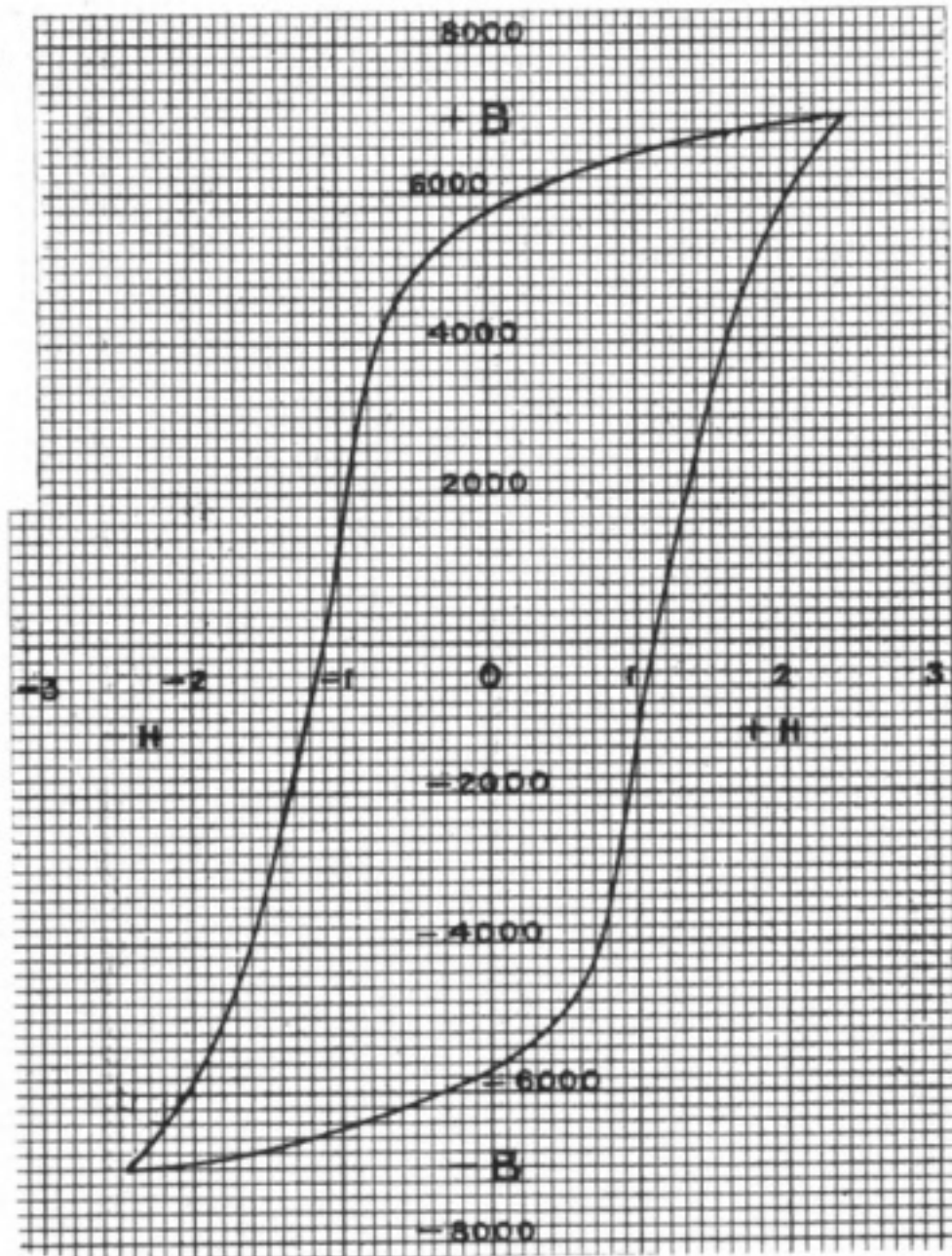

FIG. 17.

Since 1 ohm = 10^9 absolute units of resistance, to convert the inductance from c.g.s. units to practical units—*i.e.*, the henry—the formula becomes

$$\text{Inductance } L \text{ henries} = \frac{4\pi N^2 A \mu}{l \times 10^9} \times K.$$

20. Construction of an Inductance Coil.—Inductance coils for use in low-frequency circuits are always wound on iron cores, since an iron core provides a path having the least reluctance for the magnetic lines of force. In Fig. 17 is shown a hysteresis loop. This curve has been drawn from figures obtained with a sample of **soft** iron.

If now the curve is plotted to the same scale for a sample of **harder** iron—that is, one with a **greater magnetic reluctance**, it will be found that the curve is **broader** and that for the same maximum value of $H B$ would be less. At the same time when H is 0, B would be greater than in the case of soft iron. This means that the magnetic state of the iron does not recover its former condition, but is still magnetised, and to a greater extent than in the case of the soft iron.

It is seen, therefore, that since the maximum number of lines of force are required in the iron to give the greatest inductance, and as the magnetic state of the iron is required to recover and adjust itself to the varying current as rapidly as possible, the core must be made of soft iron.

21. Eddy Currents.—If the core is made of one solid piece of iron currents are induced in the iron itself, known as **eddy currents**, which tend to **reduce** the number of lines of force threading the iron, also since all currents heat the conductor the eddy currents would heat the iron core, so causing loss of energy. To overcome this the core is made up of thin sheets of iron, with a thin insulating coat, often of shellac varnish or paper between each sheet. A core built up in this way is termed a **laminated** core. The cores of armatures and transformers are laminated in this way for the same reason. Instead of using thin sheets of iron, a small gauge iron wire is sometimes used.

22. Winding.—Before winding on the wire the core is covered with a layer of insulating tape and varnished cloth.

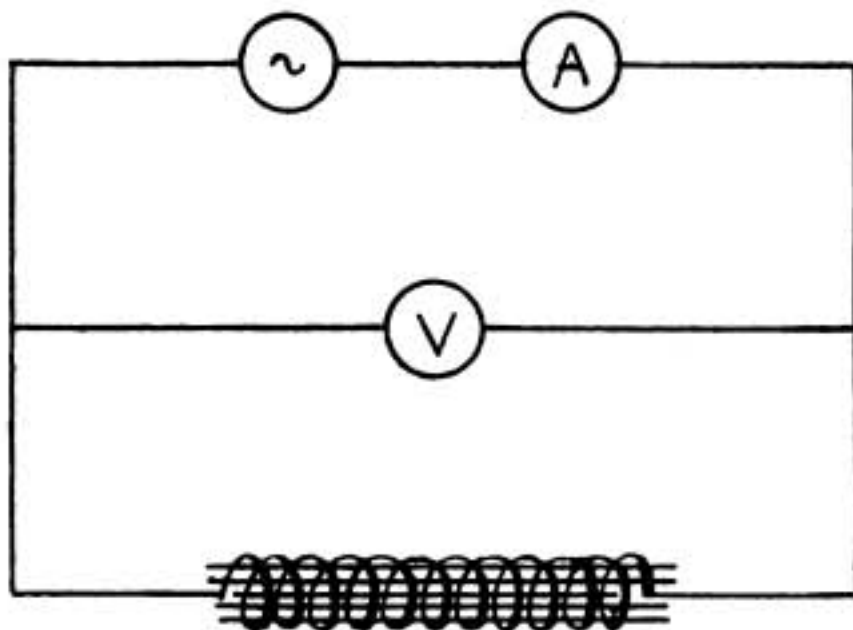

FIG. 18.

Since the voltage of the low-frequency circuit of a wireless telegraph set seldom exceeds 500 volts, the core is wound with double cotton-covered wire and then shellaced and baked.

If more than one layer of wire is used, then a piece of varnished cloth is put between each layer.

23. Measurement of E.M.F. of Self-induction.—In measuring the E.M.F. of

self-induction of inductance coils used in the low-frequency circuit of a wireless telegraph set the **resistance** of the coil compared with the **inductance** is nearly always negligible.

The simplest way to measure this E.M.F. is to connect the coil to an alternating source of supply with an ammeter in series and a voltmeter across the coil (**Fig. 18**).

The frequency and the current should be the same as that used under working condition. Then neglecting the resistance, R , which for a well-designed coil should be relatively small,

$$C = \frac{E}{2\pi nL}$$

$$\therefore L \text{ henries} = \frac{E}{2\pi nC}$$

Example :—The voltage across an inductance coil is 80 volts (r.m.s.), and the current flowing through it is 6 amperes. If the frequency is 150 periods per second, what is the inductance in henries ?

$$\text{Since } L = \frac{E}{2\pi nC}$$

$$L = \frac{80}{2\pi \times 150 \times 6}$$

$$= \frac{80}{2 \times 3.14 \times 150 \times 6}$$

$$= \frac{80}{5652}$$

$$= 0.014 \text{ henries.}$$

24. Example.—A circuit having an inductance of 0.00318 henries and a resistance of 1.5 ohms is supplied with an alternating E.M.F. of 250 volts maximum. If the frequency is 100 cycles per second,

- What will be (1) The current ;
 (2) The angle of lag ;
 (3) The back E.M.F.
 (4) The cosine of angle of lag ;
 (5) Watts expended in the circuit ?

(1) From the formula

$$C = \frac{E}{\sqrt{R^2 + (\omega L)^2}}$$

by substituting the known values we have

$$C = \frac{250}{\sqrt{1.5^2 + (2\pi 100 \times 0.00318)^2}}$$

$$C^2 = \frac{250^2}{1.5^2 + (2\pi 100 \times 0.00318)^2}$$

$$C^2 = \frac{62500}{2.25 + 4.0}$$

$$= \frac{62500}{6.25}$$

$$C = \sqrt{10000}$$

$$\therefore C = 100 \text{ amperes (maximum).}$$

$$\begin{aligned}
 (2) \quad \text{Tan } \lambda &= \frac{\text{Back E.M.F.}}{\text{Effective E.M.F.}} \\
 &= \frac{2\pi nLC}{RC} \\
 &= \frac{2\pi 100 \times .00318 \times 100}{1.5 \times 100} \\
 &= \frac{199.7}{150} \\
 &= 1.33.
 \end{aligned}$$

\therefore Angle of lag

$$\begin{aligned}
 (3) \quad E &= \sqrt{(RC^2 + E_{s,t}^2)} \\
 250 &= \sqrt{\{(1.5 \times 100)^2 + (E_{s,t}^2)\}} \\
 E_{s,t}^2 &= 250^2 - (1.5 \times 100)^2 \\
 &= 62500 - 22500 \\
 &= 40000
 \end{aligned}$$

$\therefore E_{s,t} = 200$ volts (maximum).

$$\begin{aligned}
 (4) \quad \text{Cos } \lambda &= \frac{E_s}{E} = \frac{RC}{E} \\
 &= \frac{150}{250} \\
 &= 0.6
 \end{aligned}$$

from which we can again obtain the angle of lag—i.e., 53° .

$$\begin{aligned}
 (5) \quad W_{av} &= E_v C_v \text{ ccs } \lambda \\
 &= \frac{250}{\sqrt{2}} \times \frac{100}{\sqrt{2}} \times .6 \\
 &= 177 \times 70.7 \times .6 \\
 &= 7508 \text{ watts} \\
 &= 7.508 \text{ kilowatts}
 \end{aligned}$$

This example was utilised in drawing out the sine curve diagram in Article 3.

25. Air Core Inductances.—No mention has been made of the inductance of air core inductances used with high-frequency currents. There are many formulæ in connection with this part of the subject suitable for any given conditions, but their study does not come within the scope of these articles.

For further information on the subject the reader is referred to the standard textbooks on wireless telegraphy and to the "Calculation and Measurement of Inductance and Capacity," by W. H. Nottage.

(To be continued.)

The Library Table

Nicolson



" *THE BOY'S BOOK OF BUSINESS.* By Cecil Chisholm, M.A., and Dudley W. Walton. With a Foreword by Lieut.-Gen. Sir R. S. S. Baden-Powell. Price 1s. 6d. net.

ONE of the excellent series of Books of Business published by Sir Isaac Pitman & Sons, this little volume is educative in the best sense of the term. That some of what finds a place in its pages is "above the head" of the average boy does not, in our opinion, detract from its utility in the slightest degree, and all that the authors have to say is put in a crisp chatty style likely to prove extremely attractive to young readers. Indeed, we are of opinion that their elders also will appreciate its appeal.

Particular instances possess a power of arresting the attention which is totally absent from generalisation, and the authors have hit upon a happy idea in utilising as an object lesson the pocket-knife, which every boy possesses as a matter of course. They have traced its evolution from the pristine ore to the finished article, and have demonstrated therefrom the reasons for, and methods of, modern specialisation. We may here remark *en passant* that we are glad to notice a due insistence upon the fact that Sport is a means to an end, and not an end in itself; the contrary doctrine has in the past formed a distinct blot upon many of our English scholastic institutions.

Among some young men starting on a business career we have at times encountered an impression that the study of shorthand and typewriting was liable to lead them into a *cul-de-sac*. Messrs. Chisholm and Walton admirably expose the error of such an impression. At other times we have come across lads who, on entering a large office, have appeared as though they had "lost their bearings" in the detail. Life seemed for them to be made up of card indexing, letter sorting and despatching, errand-running, etc. Business novices will be saved from such limitation of vision by the volume under review, wherein they will find delineated the true perspective of these items and the part properly belonging to them in the landscape of commercial and industrial life. Good advice abounds in these pages, and most of it will be found both sound and useful. Even when the reader may not agree with some particular item, he will find that our authors put their views so forcibly as to

coerce him into analysing his own reasons for disagreement. We will give an instance of what we mean, by referring to what appears under the head of "Diary Keeping."

Although intended primarily for youthful subordinates, a great deal of the matter will be found stimulating by older men in responsible positions. We sometimes find ourselves taking our own methods so much "for granted" that it never occurs to us to question whether they cannot be improved on. The notes on "How to Read Newspapers," in especial, might with the greatest advantage be laid to heart by many an "old hand." We will exemplify the keynote struck by the following quotation: "It is far more valuable for the business man to know what a rising in South America means, than to know merely that throats are being cut."

To sum up, we can thoroughly recommend a father to put the book into his boy's hands, and we would at the same time suggest that he read it himself before passing it on.

* * * * *

"*ELEMENTARY SCIENCE FOR ENGINEERING APPRENTICES.*" By *W. McBretney, B.Sc. (Lond.), A.M.I.E.E.* Longmans, Green & Co. Price 1s.

Drawing and engineering have a great deal closer relationship than is grasped by the superficial observer. Many a boy has a certain amount of "bent" for draughtsmanship without any special talent which is likely to fit him for artistic work, even of the humbler order. But, even so, a slight talent for drawing forms a very valuable part of the equipment of a young student of engineering. The fact is emphasised in the choice of subjects prescribed in most technical schools, and the present volume brings the matter home in a very realisable way.

It is a strictly practical and unpretentious effort to supply the needs of elementary students, and depends for its appeal upon adhesion to the modern practice of hanging all general theorems and formulæ upon practical experiment. There are eight chapters in all, and each one is supplemented by a number of questions framed for the purpose of self-examination. By means of those questions the student will be able to test his capacity for making correct drawings, measurements and calculations, as well as whether he has mastered the principles and general theorems with which they are connected.

Thus, for instance, the first chapter—devoted to the measurement of length—concerns itself with the various instruments with which the student should become familiar, and the methods by which he can best utilise them in his work and drawings. Chapter II. occupies itself with mensuration, and gives instances of the geometrical theorems of which practical use is made in everyday engineering work. Here again practice leads up to theory, and we find the formula used in working out the volume of a pyramid is led up to by an experiment in which the pupil is shown how to obtain the result by the use of the burette. Chapter III. concerns itself with mass, weight, density, etc., and here once more we find the correctness of the general theorems and formulæ experimentally demonstrated. The author devotes Chapter IV. to the general characteristics of the U-tube, barometers, etc., which he elucidates by similar practical tests, and thus leads the pupil through a series of experiments to the general statement of Boyle's law. Force, moment, centre of gravity, etc., figure in Chapter V., and these, as well as the subjects dealt with in the three remain-

ing chapters: The Expansion of Solids, Liquids and Gases; Temperature and its Measurement; Conduction, Convection, and Radiation; all receive similar treatment.

Readers will perceive that we have here a workmanlike little manual, covering—on the lines laid down by modern theories of instruction—the science syllabus usually followed in the Second Year Preliminary Technical Course.

* * * * *

THE BRITISH SHIPPING INDUSTRY. By *Edgar Crammond.* London: Constable & Company. 1s. net.

The submarine crisis has brought home to the British people the vital importance of their sea-borne trade. In this book Mr. Crammond endeavours to explain that no country is more dependent upon its imports than the United Kingdom, and as a result at the outbreak of war our stocks of food were disastrously low. Mr. Crammond has done good work in bringing together the facts relating to the British shipping industry in such a handy form, and in the three sections "British Shipping before the War," "British Shipping during the War," and "The Future of British Shipping," tells a most illuminating story. The little volume is thoroughly up-to-date (we find, for instance, references to speeches made as recently as the middle of February of this year), and the figures quoted are either drawn from official reports and speeches or are based upon intelligent surmise. The author feels some anxiety as to the policy which may be followed by the Government in relation to shipping after the war, and expresses the hope that a great Department of State may be created upon a permanent basis for the purpose of directing and fostering our shipping. If British shipping is to maintain its position, says Mr. Crammond, the actual working of the industry must be left as much as possible in the hands of the men who have brought it up to its highly developed condition before the war.

The little volume concludes with a brief reference to the debt which the Empire and our Allies owe to the officers and men of the Royal Navy and to the men of the British Mercantile Marine.

* * * * *

THE "RIGHT-ROAD" READERS. Published by the Education Co. of Ireland, Ltd., Dublin and Belfast.

It is noteworthy that even an "Intermediate Reader," for the use of schools, cannot dispense nowadays with some consideration of wireless telegraphy, and a short account of what the science means to young children will be found in the pages of this well-planned little book of selections.

* * * * *

We take this opportunity of congratulating the publishers upon the style and format of their volume, as well as upon the principles of selection followed. The extent to which present war conditions have increased the difficulties in the way of adequate and satisfactory printing can only be properly appreciated by those in close practical contact with the problems involved. Superficially, it may seem a small matter, but we are of opinion that the choice of extracts from literature put into the hands of young children is of the greatest importance. Such items remain with them during the whole of their natural life, ineradicable in a way that no subsequently absorbed matter can possibly be.

Patent Record

2656. February 22nd. G. A. Beauvais and L. N. Brillouin. Receiving apparatus for wireless telegraphy. (Convention application, France, March 27th, 1916.)
2657. February 22nd. Installation for wireless telegraphy and telephony. (Convention application, France, November 7th, 1916.)
2788. February 26th. W. H. Wilson. Apparatus for producing or utilising electrical oscillations.
2874. February 27th. P. D. Lucas. Receivers for wireless telegraphy.
2940. February 28th. R. A. Fessenden. Transmission of sound and like impulses. (Convention application, United States, May 12th, 1916. Patent No. 106268. *Open to Inspection.*)
3039. March 1st. L. Cohen. Wireless radio-signalling by the arc system.
3476. March 9th. A. M. Taylor. Regulation of voltage of alternating current systems.
3558. March 10th. W. J. Lyons and Selective Signal Co. Apparatus for the reception and utilisation of electric current impulses.
3657. March 13th. British Westinghouse Electrical Mfg. Co. Systems of control. (Convention application, United States, March 13th, 1916. Patent No. 105329. *Open to Inspection.*)
3658. March 13th. Transformation of single phase alternating electric current into polyphase currents. (Convention application, United States, March 13th, 1916. Patent No. 105330. *Open to Inspection.*)
3709. March 14th. R. A. Mack, G. H. Nash and Western Electric Co. Signalling and sound detecting systems.
3811. March 15th. H. Hurm. Crystalline and like detectors for electric waves. (Convention application, France, March 21st, 1916. Patent No. 105905. *Open to Inspection.*)
- 3974 and 3975. March 19th. E. R. Clarke. Soundwave receivers.
4174. March 22nd. R. Boin. Continuous current electric generators.
4427. March 27th. Sir G. Marconi, G.C.V.O. Reflector aerials for wireless telegraphy and telephony. (Convention application, Italy, March 28th, 1916. Patent No. 105909. *Open to Inspection.*)
4950. April 5th. Marconi's Wireless Telegraph Co., Ltd., and Harry A. Ewen. Improvements in, and relating to, electrical instruments.
5073. April 11th. A. E. McColl. Alternating current electrical systems.
5354. April 13th. K. Troisdahl. Electrical current interrupters.
5333. April 16th. A. J. Martin. Wireless receiving circuits.
5363. April 16th. M. Latour. Audion or lamp relay or amplifying apparatus for wireless telegraphy and telephony. (Convention application, France, April 15th, 1916.)
5401. April 17th. O. Loras. Transformers for alternating electric currents. (Convention application, France, June 9th, 1916.)
5451. April 18th. British Thomson-Houston Co., Ltd. (*General Electric Co., U.S.A.*). Protective devices for electrical apparatus.
5519. April 19th. Wireless signalling systems.
5577. April 20th. T. J. Grainger and J. A. W. Ward. Sound augmenting and transmitting instruments.
5738. April 24th. British Thomson-Houston Co., Ltd. (*General Electric Co., U.S.A.*) Wireless signalling systems.

Questions & Answers

NOTE.—This section of the magazine is placed at the disposal of all readers who wish to receive advice and information on matters pertaining to both the technical and non-technical sides of wireless telegraphy. There are no coupons to fill in and no fees of any kind. At the same time readers would greatly facilitate the work of our experts if they would comply with the following rules: (1) Questions should be numbered and written on one side of the paper only, and should not exceed four in number. (2) Replies should not be expected in the issue immediately following the receipt of queries, as in the present times of difficulty magazines have to go to press much earlier than formerly. (3) Queries should be as clear and concise as possible. (4) Before sending in their questions readers are advised to search recent numbers to see whether the same queries have not been dealt with before. This will save us needless duplication of answers. (5) The Editor cannot undertake to reply to queries by post, even when these are accompanied by a stamped addressed envelope.

THE following information reprinted from our excellent contemporary *Flight* will be of service to many of our readers:—

“Applications for commissions in the Royal Naval Air Service should be addressed to the Director of Air Services, Admiralty, S.W. The necessary form and conditions of entry can be obtained from the Secretary of the Admiralty.

“Applications for commissions in the Royal Flying Corps should be sent to the Director-General of Military Aeronautics, Hotel Cecil, Strand, W.C.

“Those who wish to enlist in the R.N.A.S. should apply to the nearest naval recruiting station or to the R.N.A.S. Drafting Office, Crystal Palace, S.E. Skilled mechanics are taken whatever their army classification, but unskilled men are only taken if they are classified B1, B2, or C1.

“Recruiting for the R.F.C. is closed for the time being, and any enquiries should be made to the Officer Commanding, Royal Flying Corps Depot, Farnborough.”

This month we have received as usual a number of letters from correspondents asking us the best books to study in order to acquire a good knowledge of wireless telegraphy. To all of these we would say that for those studying for the Postmaster-General's Examination the standard text book is *Handbook of Technical Instruction for Wireless Telegraphists*, by J. C. Hawkhead and H. M. Dowsett, obtainable from the Wireless Press, Ltd., price 3s. 6d., post free 3s. 10d. This contains full descriptions of apparatus used on board ship and covers the

whole theoretical course of the subject. *The Elementary Principles of Wireless Telegraphy*, by R. D. Bangay, is the best book for those who wish to obtain a good general groundwork in wireless, preparatory to taking up a course for the P.M.G. certificate. This book is in two parts. Part one, price 1s. 6d., post free 1s. 9d., covers such subjects as electricity and magnetism, details of wave motion, production of wave and high-frequency oscillations, coupled oscillatory circuits, wireless telegraph receivers, oscillations, masts, etc. Part two, price 3s., post free 3s. 3d., is more advanced, dealing with curved diagrams, the theory of the dynamo and transformer, excitation of spark transmitters, spark discharges and oscillation valves. Both the *Handbook of Technical Instruction for Wireless Telegraphists* and the two parts of *The Elementary Principles of Wireless Telegraphy* should be in the hands of every student who desires to obtain a thorough knowledge of the subject.

D2 (Barnet).—The above notes answer your first question. (2) You will find the wireless schools in London advertised in the present issue.

T. B. H. (Bootle).—It is quite possible there will be a good demand for wireless engineers after the war, and from your letter we judge that you would stand a good chance if you were to apply to The Chief Engineer, Marconi's Wireless Telegraph Co., Ltd., Marconi House, Strand, London, W.C.2, as the qualifications you possess are those demanded.

G. B. (Edinburgh) asks if a Marconi operator is entitled to a salute from soldiers and sailors and also if it is necessary for him to salute officers in the Navy *above lieutenant's rank* (the italics are ours). It should be unnecessary to inform the majority of our readers that a Marconi operator in the Mercantile Marine is not entitled to the salute for the simple reason that he is not a member of His Majesty's Forces. For the same reason it is not necessary for him to salute an officer in H.M. Forces.

RADIOSON (Zanzibar).—With reference to your queries on the cross connections of aerial wire installations being shown, very little difference is obtained by making metallic connections in the places you mention. We believe the form of aerial to be a good one for general work. At the present time we cannot discuss such points as the calculation of its wave-length, but if you refer to the *Calculation and Measurement of Inductance and Capacity*, by W. H. Nottage, you will probably be able to make the necessary calculations yourself.

With regard to your other set of questions:—
 (1) If ship's signals come in quite plainly for a short period, then die away until they become inaudible, and then later return in full strength, we think it probable that, provided the ship is within normal range and it is not a case of "creaking," the ship must be passing behind some natural obstacle such as a stretch of dry land or a hill. There is, of course, the possibility of a variation in the transmitter itself, but we presume that you have reason to think that such does not occur. If you find the same phenomenon to occur regularly with different ships, you should endeavour to make a chart and mark on it the position where signals become inaudible. From such a chart you will possibly be able to derive some valuable information. (2) The station in question referred to as "A" probably has a much bigger aerial than the ship, and also more sensitive receiving apparatus, which would possibly account for the effect you mention. (3) You say that "there is a certain place in the Gulf of Mexico where it is well known that long distance communication can take place. It is only a small area, perhaps 20 miles square." We do not know of this spot, although perhaps some of our readers may be able to tell about it. If this should catch the eye of an operator trading in the Gulf of Mexico, perhaps he would be so good as to send us some information. (4) Although we do not know of any definite places of small area where long distance communications are easily effected, it is well known that in the Pacific waters, in the South Atlantic and in the Indian Ocean very long distances can frequently be achieved at night. In the neighbourhood of Australia, for instance, distances of over 2,000 miles are frequently covered with the ordinary 1½ kw. ship installations. Very many thanks for your highly appreciative remarks regarding our magazine. It is most gratifying to us to know that our efforts are appreciated in distant parts of the Empire.

MARKI (Glasgow).—Your letter is very interesting and shows that you are devoting original thought to the solution of radiotelegraphic problems. This is a very healthy sign, and we wish more students would endeavour to work out problems for themselves in the way indicated in your letter. With regard to your first question, you will see where your reasoning is wrong if you consider the case of waves in water. You must have noticed at the seaside that where the waves meet with obstacles such as rocks, piles, etc., other waves are frequently set up, and as a result, you may say, one set of waves superimposes on another set. The same phenomenon may also be observed in cases where a sharp breeze ruffles the surface of the water. Here you may see two sets of waves flowing in different directions, one set being caused by the local wind and the other coming in from the ocean in the ordinary way. If you apply this analogy to your reasoning regarding the simultaneous occurrence of light and wire-

less waves in the ether, you will see why it is that the two forms do not interfere with one another, but will simply be superimposed. Although many scientists and experimenters have endeavoured to solve the problem of why wireless signals are generally stronger at night time than in day no satisfactory explanation has yet been found. A theory held in some quarters is that the sunlight, possibly by some ionising effect, makes the atmosphere electrically "foggy" during the day, the effect passing off as soon as the sunlight disappears. This, however, does not explain why the effect is not noticed over distances up to 200 or 300 miles. Questions 2 and 3. The time taken for light to travel from some of the distant stars is of course considerable, and if some of them were to cease to be luminous we should see their light for some days, months or even years (depending on their distance) afterwards. Similarly the light we see from the sun is not that which actually leaves the sun's surface at the moment of observation, but rays which started on their way many seconds before. A few years ago a well-known scientist, in lecturing on this subject, remarked that if some of the stars were inhabited and we had sufficiently powerful telescopes to observe what was taking place on their surface we should be able to watch the happenings of the time of Queen Elizabeth. From this it follows that if we were able to communicate by wireless with the same stars we should have to wait a long while for a reply to our message.

A number of queries are held over for lack of space.

**THIS MAGAZINE CAN BE SENT
 FREE TO OUR TROOPS ABROAD BY
 LEAVING IT AT A POST OFFICE.**

A PARTMENTS, special terms to Marconi Students *only*, 15 minutes by tube to "The Strand," good table, excellent references, 16/6 per week inclusive.—MRS. BARRY YORKE, 22 Hogarth Road, Earl's Court, London, S.W.

THE YEAR-BOOK OF WIRELESS TELEGRAPHY & TELEPHONY.—We have had the opportunity of securing a few copies of earlier issues and can offer them as follows—
 1914 edition, 12 copies only, 3/- post free United Kingdom 4/- Abroad.
 1915 edition, 4/- United Kingdom; 5/- Abroad.
 THE WIRELESS PRESS, LTD., Marconi House, Strand, London, W.C.

SPECIMEN COPIES.—We shall be pleased to send *entirely free of charge* a few specimen copies of **THE WIRELESS WORLD** to the friend of any reader likely to be interested in the magazine.—Send a postcard to Sales Manager, **THE WIRELESS WORLD**, Marconi House, W.C.

The simplest method of obtaining "THE WIRELESS WORLD" — Place a standing order with your newsagent